

# Operator's Manual



**CENTURION**  
WORLD CHAMPIONSHIP TOWBOATS



Fineline Industries LLC  
2047 Grogan Avenue  
Merced, CA 95341  
209-384-0255

[www.centurionboats.com](http://www.centurionboats.com)

# CENTURION BOATS

## TABLE OF CONTENTS

<b>Introduction</b> .....	1-1
Congratulations .....	1-1
About This Manual .....	1-2
About Your New Boat.....	1-3
<b>Warranty</b> .....	2-1
Warranty.....	2-1
<b>Safety</b> .....	3-1
General Safety .....	3-2
Good Boating Practices .....	3-2
Tow Boat Safety .....	3-4
Safety Decals and Statements.....	3-20
Carbon Monoxide.....	3-31
Required Boating Safety Equipment and Regulations .....	3-32
Recommended Safety Equipment.....	3-39
Seating Locations.....	3-40
<b>Boating Regulations &amp; Your Responsibilities</b> .....	4-1
Boat Owner / Operator Responsibilities .....	4-1
Safety .....	4-2
Registration .....	4-2
Insurance .....	4-2
Reporting Accidents .....	4-2
Boating Under the Influence.....	4-3
Operator's License and Education .....	4-3
Operation by Minors .....	4-3
Emergency Assistance.....	4-4
Protecting the Environment.....	4-4
Foreign Species Transportation .....	4-4
Noise .....	4-4
Speed.....	4-4
Wake .....	4-4
Pollution Regulations .....	4-5
<b>Emergencies</b> .....	5-1
First Aid / Medical Emergencies.....	5-1
Emergency Preparation Checklist.....	5-1
Carbon Monoxide Poisoning .....	5-1
Fire and Explosion .....	5-2
Using Distress Signal Devices and Calling for Help.....	5-3

Capsizing and Flooding .....	5-4
Man Overboard.....	5-4
Running Aground .....	5-5
Dangerous Weather .....	5-6
Engine or Boat System Failure.....	5-6
Accidents, Collisions and Giving Assistance .....	5-6
Towing on the Water .....	5-6
<b>Operating in Hazardous Conditions .....</b>	<b>6-1</b>
Severe Weather.....	6-1
Water Hazards.....	6-2
Restricted Areas .....	6-3
Markers, Warnings and Advisories.....	6-4
<b>Navigation Rules and Aids .....</b>	<b>7-1</b>
Audible Distress Signals.....	7-1
Right-of-Way.....	7-2
Navigational Lights & Night Operation.....	7-2
Speed .....	7-3
Wake .....	7-3
Overtaking / Passing .....	7-3
Meeting Head-On .....	7-4
Crossing .....	7-5
Aids to Navigation.....	7-6
<b>Controls, Features and Options .....</b>	<b>8-1</b>
Tow Boat Technology.....	8-1
Steering System .....	8-6
Helm .....	8-6
Switches and Breakers.....	8-10
Fuel System.....	8-15
Engine Cooling System .....	8-16
Engine Exhaust System .....	8-17
Engine Lubrication System.....	8-17
Electrical System .....	8-17
Bilge Pump System .....	8-18
Ballast Tank System (Optional).....	8-19
Ramfill Ballast Operation.....	8-20
Propeller Strut.....	8-21
Propeller .....	8-22
Engine Compartment Ventilation System.....	8-24
Trim Tab/Stinger Wake Plate (Optional).....	8-24
Wake Tower (Optional).....	8-25
Cockpit Heater System (Optional).....	8-25
<b>Operating Your Boat.....</b>	<b>9-1</b>
Safety Precautions .....	9-1
Before Getting Under Way .....	9-1

Getting Under Way.....	9-6
<b>Trailing and Launching</b> .....	10-1
Legal Considerations .....	10-1
Trailer Type .....	10-1
Trailer Classification .....	10-1
Trailer Gross Vehicle Weight Rating .....	10-2
Vehicle Towing Hitch.....	10-2
Hitch Ball and Trailer Coupler .....	10-3
Safety Chains.....	10-4
Towing Vehicle.....	10-4
Trailer Brakes.....	10-5
Trailing Guidelines .....	10-6
Launching.....	10-8
Loading Guidelines .....	10-9
<b>General Care and Maintenance</b> .....	11-1
Hull Discoloration .....	11-1
20-Hour Inspection.....	11-2
25-Hour Engine Inspection.....	11-2
Periodic Maintenance.....	11-3
Engine .....	11-3
Fuel System .....	11-3
V-Drive .....	11-4
Steering System .....	11-4
Electrical System.....	11-5
Corrosion Protection.....	11-7
General Maintenance and Cleaning.....	11-8
Safety Equipment.....	11-11
General Boating Equipment .....	11-11
Trailer .....	11-12
<b>Winterization and Storage</b> .....	12-1
Winterization and Storage Preparation .....	12-1
Engine & V-Drive Winterization.....	12-2
Storing on a Cradle or Blocks.....	12-2
Storing on a Trailer.....	12-3
Recommissioning After Storage.....	12-3
Lifting.....	12-5
<b>Troubleshooting</b> .....	13-1
<b>Glossary of Nautical Terms</b> .....	14-1

**This Page Intentionally Left Blank**

# CENTURION BOATS

## *Section 1*

# INTRODUCTION

## CONGRATULATIONS

You have just become a member of the Centurion Boats family. This manual contains recommended maintenance procedures to be used in the care of your new boat. It is important that you read this information and familiarize yourself with all the boat systems prior to operating or hauling your new Centurion Boat.

First read the warranty and disclaimer enclosed, then make sure your warranty activation card has been sent to Fineline Industries to activate your warranty. If you have any questions after reading this manual, please contact your local authorized Centurion dealer.

Our mission at Centurion Boats is to continually strive to build the finest product in the market place. We have set our standards high and would like you, our customer, to know that we build pride into every boat model manufactured here at Centurion Boats. One hundred percent customer satisfaction is the goal we strive to achieve daily.

## ABOUT THIS MANUAL

Please keep this *Operator's Manual* on-board for future reference and pass it along to the new owner if you ever decide to sell the boat.

This manual has been written as a general guide to safe operating practices, boating regulations and maintenance techniques for recreational boating.

This manual is not intended to be used as a replacement for specific information and procedures covered in manuals provided by the manufacturer of the engine, trailer and other major equipment.

Suppliers of some of the major components in your boat provide care and operation information that has been included with your boat in your *Owner's Information Kit*. Read the information in this manual and the information in the *Owner's Information Kit* completely before operating your boat or any equipment.



**Figure 1-1**

Because we are constantly working toward product improvement, this manual is intended to be a general guide only. The illustrations used in this manual may not exactly match the equipment on your boat; they are intended only as general reference views.

If this is your first time owning or operating a boat, it is recommended that you contact your dealer or local boating agency to find out how to enroll in a boater safety course prior to operating the boat.





# Section 1

inner liner is then injected with foam to reduce noise and vibration, and the injection points are sealed with additional fiberglass, ensuring there is no exposure to water while your boat is under way.

Electrical wiring, gas tanks and underwater gear components are installed before the final ICS pieces are added. The deck is then placed in the hull using a "Reverse Shoebox" method, which reduces the influx of water into the boat through the rub rail and creates the strongest bond possible. Plexus is applied to the hull and deck and then tightened together using stainless steel screws, allowing the Plexus to take effect.

Final assembly is made with the installation of a PCM engine, final drive system components and interior boat features. When assembly is completed the boat is lake-tested and detailed.

Centurion Boats is dedicated to revolutionizing towboat performance. In our testing and development facilities we work passionately on the water to develop new ways to push Centurion Boats ahead of the pack. Visit us at: [www.centurionboats.com](http://www.centurionboats.com)

So, whether you're just cruising on one of our boats or seriously competing behind one, here are a few Centurion innovations that will help you carve the waves (Features not available on all models):

- **Integrated Composite System (ICS) Construction**

Integrated Composite System is composed of a three-piece process that combines hull, inner liner and deck, which results in 100% composite designs that are strong and light.

- **Snap-Out Carpet**

Convenient, 40 oz. marine-grade carpet that simply snaps out of the boat for easy cleaning and storage.

- **Gelcoat Graphics**

Most graphics and colors are generated by a computer-rendered graphic system and are applied into the gelcoat. Centurion Boats stand alone when it comes to gelcoat graphics.

## Hull Identification, Capacity and Safety Plates

### Hull Identification Number

The hull identification number is located on the upper right-hand side of the transom just below the rub rail.

The HIN must be clearly visible and may not be removed, altered or tampered with in any way as regulated by federal law.

In case of collision, theft or damage, report these numbers to the local authorities, your insurance agent and your dealer. Safeguard information about your boat by recording the HIN and model of your boat and model and serial numbers of the engine, trailer and accessories on the *Boat Information Form* on page 1-9.



**Figure 1-3**

## Capacity Plate

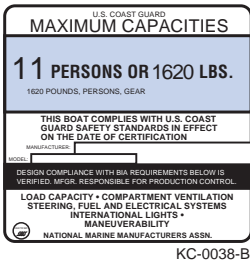

All mono-hull recreational boats less than 20 feet (6 meters) require a gross weight and person-capacity plate to be clearly displayed as provided by the manufacturer.

Boats in the National Marine Manufacturers Association (NMMA) program up to 26 feet (7.9 meters) have a maximum rated load capacity, which is stated on the certification plate.

The person/load capacity is determined by the USCG. The capacity plate is located within clear visibility of the boat operator or helm area. The capacity plate indicates limits for loading the boat, which are enforceable by law. Never exceed the “U.S. Coast Guard Maximum Capacities” indicated on the capacity plate.

## U.S. Coast Guard Safety Standards Compliance Plate

All power boats less than 20 feet (6 meters) must have a manufacturer's compliance plate clearly indicating that your boat is in compliance with the USCG safety standards and the effective date of the compliance. The compliance plate may be combined onto one plate showing both the capacity plate and compliance information by the manufacturer.

## References and Contact Information

Use the following list of publications and organizations for reference and contact information concerning safe boating, navigational rules and other boating topics.

### Publications

- Bottomley, Tom. *Boatman's Handbook*. Hearst Marine Book. Morrow
- Brotherton, Miner. *Twelve Volt Bible*. Seven Seas
- Chapman, Charles F. and Maloney, E.S. *Chapman's Piloting, Seamanship and Small Boat Handling*. Hearst Marine Book. Morrow
- Damford, Don. *Anchoring*. Seven Seas
- National Fire Protection Association. *Fire Protection Standard for Pleasure and Commercial Motor Craft*. National Fire Protection Association
- Strahm, Virgil. *Does Your Fiberglass Boat Need Repair?* Strahm
- United States Coast Guard. *Navigational Rules for U.S. Waterways*. United States Coast Guard. Visit <http://www.navcen.uscg.gov/mwv/NavRules> to view or download this publication.
- United States Coast Guard Auxiliary. *Boating Skills and Seamanship Thirteenth Edition*. United States Coast Guard

- Whiting, John and Bottomley, Tom. *Chapman's Log and Owner's Manual*.  
Hearst Marine Book

## **Organizations**

### ***American Boat & Yacht Council***

<http://abycinc.org>

### ***American Red Cross***

<http://www.redcross.org> or consult your local telephone directory

### ***Boat Owners Association of The United States***

<http://www.boatus.com/>

### ***BoatU.S. Foundation for Boating Safety Hotline***

<http://www.boatus.org/onlinecourse>

Phone: 800-336-BOAT (In Virginia call 800-245-BOAT)

### ***INT League (International Water Sports Organization)***

<http://www.intleague.com>

### ***International Water Ski Federation***

<http://www.iwsf.com>

### ***National Association of State Boating Law Administrators***

<http://www.nasbla.org>

### ***National Marine Manufacturers Association***

<http://www.nmma.org>

### ***National Oceanic and Atmospheric Administration's National Weather Service***

<http://www.nws.noaa.gov>

### ***National Safe Boating Council Inc.***

<http://www.safeboatingcouncil.org>

### ***Sea Tow Services International, Inc.***

<http://www.seatow.com>; Phone: 631-765-3660; Fax: 631-765-5802

Toll free: 800-4SEATOW (800-473-2869)

### ***U.S. Coast Guard***

<http://www.uscg.mil> (To contact the U.S. Coast Guard for an emergency while on the water, always use your on-board VHF-FM radio Channel 16. Use cell phones only as a secondary means of communication. Call 9-1-1 to reach rescue personnel.)

### ***U.S. Coast Guard Auxiliary***

<http://nws.cgaux.org>; Phone: 877-875-6296

# Section 1

## **U.S. Coast Guard Auxiliary – Float Plan Information**

<http://www.floatplan.uscgaux.info>

## **U.S. Coast Guard Navigation Center (NAVCEN)**

<http://www.navcen.uscg.gov>

## **U.S. Coast Guard Office of Boating Safety**

<http://www.uscgboating.org>

## **U.S. Coast Guard Pollution Control National Response Center**

Phone: 800-424-8802

## **U.S. Coast Guard’s America’s Waterway Watch Program**

(A program for recreational boaters to assist the U.S. Department of Homeland Security in reporting suspicious activity on U.S. waterways)

Phone: 877-24-WATCH (877-249-2824)

## **U.S. Government Printing Office**

<http://www.gpoaccess.gov>

(For information and documentation on FCC rules and regulations and Skippers Course information, and other government, marine and nautical related documents)

## **U.S. Power Squadrons**

<http://www.usps.org>; Phone: 888-367-8777

## **USA Water Ski**

<http://www.usawaterski.org>

## **Water Sports Industry Association**

<http://www.wsia.net>

## **World Wakeboard Association**

<http://www.thewwa.com>

## Boat Information Form

BOAT	
Boat Model:	Hull ID Number (HIN):
Hull Colors:	
Weight:	Registration Number:
Length:	Registration State:
Draft:	Purchase Date:
Beam:	Delivery Date:
Vertical Clearance:	Warranty Expiration Date:
Dealer:	Boat Manufacturer:
Dealer Representative:	Manufacturer Representative:
Dealer Phone:	Manufacturer Phone:
ENGINE, DRIVE and PROPELLER	
Engine:	Model Number:
	Serial Number:
Drive:	Model Number:
	Serial Number:
Propeller:	Make:
	Type:
	Size:
	Material:
	Part Number:
ACCESSORIES	
Fuel Tank Capacity:	Battery Make:
Fuel Filter Part Number:	Battery Size:
Ignition Key Number:	
TRAILER	
Trailer	Model Number:
	Serial Number:
	GVWR:
	Tire Size:

**This Page Intentionally Left Blank**





## Section 2

# WARRANTY

## WARRANTY

### Limited Warranty Statement

#### Section 1. Disclaimer and Limitation of Implied Warranties:

THE EXPRESS LIMITED WARRANTY SET FORTH HEREIN BELOW IS EXCLUSIVE AND IN LIEU OF ALL OTHER WARRANTIES, TERMS AND CONDITIONS, EXPRESS OR IMPLIED, EITHER IN FACT OR BY OPERATION OF LAW, STATUTORY OR OTHERWISE. FINELINE INDUSTRIES, LLC DISCLAIMS, AND THE OWNER HEREBY EXPRESSLY WAIVES, TO THE MAXIMUM EXTENT PERMITTED BY APPLICABLE LAW, ANY AND ALL OTHER WARRANTIES OR REPRESENTATIONS OF ANY KIND OR NATURE, INCLUDING, BUT NOT LIMITED TO, THE IMPLIED WARRANTIES OF MERCHANTABILITY AND FITNESS FOR A PARTICULAR PURPOSE. Some states or provinces do not allow the exclusion or limitation of implied warranties, as such the above limitations and exclusions may be limited in their application to Owner. When the implied warranties are not allowed to be excluded in their entirety, they will be limited to the duration of the express warranty periods applicable to the respective components.

This Limited Warranty gives you specific legal rights. You may have other rights, which vary from state to state.

#### Section 2. Limited Warranty (“Limited Warranty”) and its Duration:

Fineline Industries, LLC (“Centurion”) warrants to the original retail purchaser that the following components of each new and unused boat manufactured by Centurion shall be free from material defects in materials and workmanship to the extent set forth below, under normal use and service when operated and maintained in accordance with Centurion’s instructions, beginning on the date of the original retail purchase of the boat by purchaser from an authorized Centurion dealer for the period indicated in this Section:

## Section 2

- **Deck, Hull and Liner (Structural Components):** The deck, hull and liner system are warranted for as long as the original retail purchaser or authorized transferee (as detailed below) owns the boat.
- **Gel Coat:** For a period of five (5) years commencing on the date the boat is purchased by the first retail purchaser through an authorized Centurion dealer, Centurion, will repair substantial manufacturing defects to the Gel Coat finish which relate to the materials supplied or workmanship by Centurion in applying the finish. This warranty right is subject to and conditioned upon the owner having provided regular maintenance and care to this component as described in the Centurion Owner's Manual. This Gel Coat limited warranty shall not extend to, and Centurion hereby expressly disclaims responsibility for, Gel Coat damages including finish blistering, discoloration, fading or osmosis or any damage resulting from in-water storage without proper bottom paint and barrier coat service and application. This warranty does not extend to these gel coat losses/damages because there is a high probability that such damages resulted from customer care and maintenance issues and/or environmental operating conditions, all of which are factors outside of Centurion's reasonable control.
- **Other Component Parts (Excluding Engine and Transmission):** Except for the engine, trans-mission and components parts described elsewhere, Centurion warrants to the original retail purchaser or authorized transferee (as described below) that the components of each new Centurion boat, as originally manufactured by Centurion and not modified by Owner, shall under normal use and service be free of defect in material and workmanship for a period of five (5) years from the date of delivery to the original retail purchaser. The components identified herein are subject to the following warranty terms, policies and conditions:
  - ◆ Instrumentation, including gauges, is warranted for 3 years parts and labor and an additional 2 years for parts only.
  - ◆ Audio and electronics systems are warranted for three (3) years.
  - ◆ Marine carpeting is warranted for 3 years parts and labor and an additional 2 years for parts only.
  - ◆ Upholstery vinyl material is warranted for 3 years parts and labor and an additional 2 years for parts.
  - ◆ Upholstery stitching is warranted for one (1) year.

## **Section 3. Engine/Power Train and Trailer/Trailer Component Parts:**

### **• Engine/Power Train:**

The engines used in Centurion boats are not manufactured or warranted by Centurion. They are supplied to Centurion by Pleasurecraft Marine Engine Company ("PCM"), which offers a separate warranty to owners of five (5) years from the date of the original retail purchase of the boat or the initial use of the boat, whichever first occurs, for the engine and power train. Centurion provides no independent warranty with regard to the engine and transmission; however, the owner may contact Centurion to obtain contact information for making claims or inquiries under the applicable engine manufacturer's warranty. Owner should refer to Pleasurecraft Marine Engine Company Owner's Manual and warranty documents for further information on terms and conditions of the engine/power train warranty.

### **• Trailer and Trailer Component Parts:**

Trailer and trailer component parts are not manufactured or warranted by Centurion. These components and parts are supplied by Extreme Custom Trailers of Rialto, CA. Centurion offers no independent warranty with regard to the trailer and trailer component parts; however, the owner may contact Centurion to obtain contact information for making claims or inquiries under the applicable trailer and trailer component parts manufacturer's warranty. For trailer warranty details, owner should refer to and rely upon the Trailer Owner's Manual and warranty documentation.

## **Section 4. Limited Warranty Conditions, Limitations and Exclusions:**

This Limited Warranty, as further described in Section 2, constitutes the final, complete and exclusive statement of warranty terms, and supersedes any and all prior written and oral statements or representations concerning the warranty on the boat. Supreme neither assumes or authorizes any other person to extend or expand upon any warranty right or grant further warranty rights on the boat or its components.

Centurion reserves the right to improve its products through changes in design or material without being obligated to incorporate such changes in products of prior manufacture.

The Limited Warranty set forth in Section 2 (including all subsections therein) DOES NOT cover or extend to any of the following:

- Normal and routine maintenance of the boat, or any component thereof;
- Normal wear and tear of boat, or any component thereof;
- Any components that are fastened to or applied to the hull or deck;

## Section 2

- Damage caused by misuse, neglect, negligence, accident, collision or impact with any object;
- Damage caused by defects in materials, components or parts not supplied or manufactured by Centurion;
- Damage caused by any improper or unauthorized alteration or modification to the boat or any of its component parts or accessories;
- Damages caused by heat, fire, explosion or freezing (including, but not limited to, damages resulting from the failure to perform proper winterization of the boat);
- Damage caused by the use of improper or contaminated fuel or fluids;
- Damage caused by failure to maintain the boat in accordance with the maintenance provisions in the Owner's Manual, by improper maintenance of the boat or by service furnished from unauthorized repair and service providers;
- Damage caused by the installation of non-Centurion materials, components or parts;
- Damage caused by the failure to comply with any recall or request for repair;
- Damage caused by lightning, hail, rain, flooding, wind, sand, floods or other environmental or natural conditions;
- Damage caused by theft or vandalism;
- Damage caused by atmospheric fallout, chemical treatments, tree sap, salt, ocean spray, mold, or animal droppings;
- Damage resulting from the use of the boat for any racing, speed, commercial competition or performance demonstration;
- Damage resulting from use of the boat for rental, commercial or industrial purposes;
- Damage caused by aftermarket cleaning products or non-Centurion approved additives;
- Damage due to insufficient or improper maintenance, including use of oils, lubricants or fluids other than those recommended in the boat's Owner's Manual;
- Damage to hardware and other components fastened or adhered to the hull, deck or liner;
- Damage to any component parts and accessories not manufactured by Supreme, including but not limited to, the engine, drivetrain, transmission, propeller, shift and throttle control levers and cables, pumps, blowers, windshields, canvas, tower and accessories, instrumentation and steering systems; however, such items may be warranted by the individual manufacturer, and where applicable, Supreme will furnish the owner with a copy of the manufacturer's warranty;
- Damage caused by davits, a hoist system or boat lift of any kind that is utilized to support the boat;
- Conditions resulting from use of the boat for anything other than recreational purposes;

- Manufacturing variations or imperfections in cosmetic, convenience or aesthetic components or features of the boat, including the gel coat finish, which have no substantial impact on the use, value or safety. As the gel coat finish is applied manually by a Centurion craftsman, minor distortions or imperfections may be found in certain areas of the boat. Such distortions and imperfections are considered normal and not subject to warranty coverage and repair;
- Damage to paint, varnishes, gel coat surfaces and colors, chrome-plated or anodized finishes, floor and floor covers and any other surface coatings, as well as damage resulting from in-water storage without proper barrier coat and bottom paints. (NOTE: Although Centurion uses the highest-grade gel coat materials, a condition may develop where the bottom of the boat may show signs of discoloration and/or blisters if the boat is left in the water for long periods of time. To properly protect the boat, boat users should apply proper barrier coat and bottom paint whenever it is anticipated that the boat will be left in the water for an extended period of time);
- Damage caused by overloading, improperly weighting or overpowering the boat;
- Damage caused by use of any trailer not sold through Centurion for the boat;
- Damage caused by water intrusion into any part of the boat (including the glove box);
- Damage caused by dealer-installed options or accessories;
- Damage caused by consumer-installed options or accessories;
- All warranty coverage will expire after ninety (90) days on boats used for any commercial purposes;
- Any and all expenses including, but not limited to, costs incurred for haul-out, launching, towing, and storage charges, telephone, expedited shipping of replacement parts, or rental charges of any type (including slip fees);

The following events will discharge Centurion from its obligations under the Centurion Limited Warranty:

- Unauthorized disconnection, tampering with, or altering of the boat's hour meter;
- Unauthorized disabling of any Centurion installed warning device or system;
- Unauthorized disconnection, disturbance or compromise of any wires, hoses, tubes, cables, looms or other components of the boat's electrical or fuel systems;
- Determination by any state or federal entity or private insurance carrier that the boat is a total loss of value or fit only for salvage.

The Limited Warranty does not provide coverage to any boat which has ever been:

- A repossession from a retail customer;
- Purchased from a salvage yard;
- Purchased from an auction;

## Section 2

- Purchased from an insurance company that obtained the product as a result of an insurance claim.

The Limited Warranty does not cover the costs of maintenance, which includes, but is not limited to, boat inspections, lubrication, engine tune-ups, replacement of filters, coolants, spark plugs, bulbs, fuses, impellers, packing material, cleaning and polishing.

### Section 5. Limitation of Liability

- **Purchase Price Limitation:** Centurion's sole obligation and liability under any provision of this Limited Warranty shall be limited, at Centurion's option and expense, to the repair or replacement of the boat or component part, or the refund of the purchase price paid by the consumer of the boat or component part found to be defective within the applicable warranty period. To the maximum extent permitted by applicable law, this shall constitute Centurion's sole liability and obligation in the event of any claim of breach of warranty. Because some states and jurisdictions do not allow the exclusion or limitation of liability, the above limitations may not apply to you.
- **Liability Limitation-Exclusion of Consequential Damages:** This Limited Warranty is for the benefit of the owner and Centurion, and shall not create or evidence any right in any third party. TO THE MAXIMUM EXTENT PERMITTED BY APPLICABLE LAW, CENTURION SHALL IN NO EVENT BE LIABLE FOR ANY INCIDENTAL, CONSEQUENTIAL, SPECIAL, INDIRECT, PUNITIVE OR EXEMPLARY DAMAGES OR LOST PROFITS WHATSOEVER ARISING OUT OF THE USE OR INABILITY TO USE THE BOAT OR ANY COMPONENT PART THEREOF, OR FOR ANY BREACH OF THIS LIMITED WARRANTY OR OTHERWISE, EVEN IF CENTURION HAS BEEN ADVISED OF THE POSSIBILITY OF SUCH DAMAGES OR SUCH DAMAGES COULD REASONABLY HAVE BEEN FORESEEABLE BY CENTURION. [Disclaimer: Some states do not allow the exclusion or limitation of incidental or consequential damages, so the above limitation or exclusion may not apply to you.]

### Section 6. Warranty, Warranty Registration and Warranty Transfer

- **Warranty:** In order to obtain warranty service under this Limited Warranty, the owner must notify the selling dealer in writing within (30) days after the discovery of any claimed defect and prior to initiating any repair. Centurion reserves the right to inspect and/or to require further evaluation and/or information regarding a warranty claim against a boat prior to its repair as well as designate the place of the warranty repair.

If you need assistance locating an authorized Centurion service facility, please visit our Centurion website at [www.centurionboats.com](http://www.centurionboats.com) or call Centurion at (209)384-0255.

Fineline Industries, LLC  
Attention, Warranty/Customer Service Department  
2047 Grogan Avenue  
Merced, CA 95341  
(209) 384-0255

Subject to the terms of this Limited Warranty, any covered boat or component part with a material defect in materials or workmanship that is returned to an authorized Centurion dealer's service department during the covered warranty period will be repaired or replaced, in Centurion's sole discretion, without charge to the customer. This provision is subject to the following terms and conditions:

- ◆ Centurion shall be responsible only to repair or replace those items that are defective, in Centurion's sole discretion, upon examination by a Centurion authorized dealer's service department or Centurion's own factory personnel;
  - ◆ Centurion warrants its repairs and replacements only for the remainder of the applicable warranty period;
  - ◆ Centurion shall, in its sole discretion, fulfill its responsibility to repair or replace any defective item at its authorized dealer's service department; and
  - ◆ The owner shall be responsible for all costs associated with the transportation of the boat, towing bills, trailer or component part(s) to the authorized Centurion service department and for any return transportation.
- **Warranty Registration:** Within seventy-two hours (72) of the first retail sale of a Centurion Boat, the boat must be registered for product warranty purposes under applicable federal law, and the following steps must be performed in order to complete the warranty registration process for all Centurion Boats:
    - ◆ Dealer is obligated to complete the warranty registration for the retail purchaser (boat owner) using Centurion's on-line dealer system.
    - ◆ Dealer must notify Centurion, via the electronic registration system that the boat has been purchased, and that all required information, including the warranty registration card signed by the boat owner, must be submitted in connection with the warranty registration for the boat owner.
    - ◆ Centurion should be notified promptly by owner of any change in address.

## Section 2

As the boat owner, you should ensure that the dealer has complied with this requirement. Warranty registration is vital. With proper registration and updated contact information, Centurion has the ability to provide information to you with your Centurion boat and allows Centurion to notify you or any mandatory recalls or other issues requiring your attention.

- **Warranty Transfer:** In accordance with the provisions of the Centurion Limited Warranty, if the Centurion boat is subsequently sold by the original retail purchaser, a transferable warranty will be offered to the second owner only for the remaining unexpired warranty coverage provided under the Limited Warranty. With regard to the Lifetime Limited Warranty on the Structural Components (deck, hull and liner) as described in Section 2, the original retail purchaser can transfer on the condition that the sale of the boat by the original retail purchaser occurs within five (5) years of the date of the original retail purchase of the boat. The Limited Warranty cannot be transferred on further sales or sales which are completed after the fifth (5th) year of ownership.
  - ◆ The Limited Warranty will be transferred upon the receipt and verification of:
    - The completed form below
    - A copy of the sales agreement/invoice;
    - A payment of \$400, made payable to Finline Industries, LLC

The transfer registration **MUST BE RECEIVED WITHIN 15 DAYS OF THE SALE DATE**. With timely submission or transfer data, the warranty will be transferred retroactive to the sale date.

### Warranty Service

**Boats with hull Identification numbers (HIN) starting with “FIN” contact Centurion customer service:**

Finline Industries, LLC  
2047 Grogan Avenue  
Merced, CA 95341  
Phone: 209-384-0255

Visit us at [www.centurionboats.com](http://www.centurionboats.com)



# CENTURION BOATS

## *Section 3*

# SAFETY

Safety is the number-one priority for Centurion Boats. Every Centurion Boat is built to meet all applicable safety standards for water sports use; however, built-in safety mechanisms are never a substitute for good judgment. As a boat operator, you always take the responsibility upon yourself to operate your boat in a safe manner. Centurion continually strives to provide you with the best technology and information to keep you safe. If you ever have any safety-related questions, suggestions or concerns, please contact us directly.

**Fineline Industries, LLC**

2047 Grogan Avenue

Merced, CA 95341

Phone: 209-384-0255

# GENERAL SAFETY

The popularity of boating and other water sports has undergone an explosion of growth in the past few years, making safety an important issue for everyone who shares in the use of our waterways.

**WARNING! Read and understand this Operator's Manual, the Engine Operator's Manual and all manufacturer-supplied information regarding the operation of equipment. As a boat owner, you must understand all safety information responsibilities, regulations, controls and operating instructions before attempting to operate your boat. Improper operation can be extremely dangerous and/or fatal.**

The safety content and precautions listed in this manual and on the boat are not all-inclusive. If a procedure, method, tool or part is not specifically recommended, you must feel confident that it is safe for you and others, and that your boat will not be damaged or become unsafe as a result of your decision. REMEMBER – ALWAYS USE COMMON SENSE WHEN BOATING!

As a boat owner, you are responsible for your own safety, as well as that of your passengers and other boaters.

## GOOD BOATING PRACTICES

Boating-related accidents are generally caused by the operator's failure to follow basic safety rules or written precautions. Most accidents can be avoided if the operator is completely familiar with the boat and its operation and can recognize potentially hazardous situations.

In addition to everyday safety, failure to observe safety recommendations may result in severe personal injury or death to you or to others. Use caution and common sense when operating your boat. Do not take unnecessary chances! Failure to adhere to these warnings may result in severe injury or death to you and/or others.

Read this entire manual and be aware of other specific safety guidelines not listed below. Seek additional safety information from the USCG, state and local authorities. In addition to specific safety statements noted in this manual, a general list of safety guidelines and recommendations is listed below:

- Your boat must comply with USCG safety equipment regulations.
- Before each outing, check all safety equipment such as fire extinguishers, life jackets, flares, distress flags, flashlights and engine stop switch. Be sure all safety equipment is operable, in good condition, readily visible and easily accessed.
- On-board equipment must always conform to the governing federal, state and local regulations.

- Never allow any type of spark or open flame on-board. It may result in fire or explosion.
- Take the keys with you when you leave the boat to keep untrained and unauthorized persons from operating the boat.
- Know how to react correctly to adverse weather conditions, have good navigation skills and follow the navigational rules as defined by USCG, state and local regulations.
- Check local weather reports before casting off. Do not leave the dock area when strong winds and electrical storms are in the area or predicted to be in the area.
- Seek shelter from open water if lightning is an imminent threat.
- Tell someone of your travel plans before departing.
- Know the weight capacity of your boat. Never overload your boat.
- Never operate the boat while under the influence of drugs or alcohol.
- Look before you turn the boat. As a boater you are obligated to maintain a course and speed unless it is safe to alter course and speed. Look before you turn.
- Operators must read and understand all operating manuals supplied with the boat before operation.
- Whenever you are going for an outing, make sure that at least one passenger is familiar with the operation and safety aspects of the boat in case of an emergency.
- Do not allow passengers to sit in front of the operator; always avoid obstructing the operator's view.
- Show all passengers the location of emergency equipment and explain how to use it.
- Never allow passengers to drag their feet or hands in the water, or sit on the bow, deck or gunwale while the engine is running.
- Never use or hold onto the boarding platform while the engine is running.
- Never stand or allow passengers to stand in the boat or sit on the transom, seat backs, engine cover or sides of the boat while the engine is running. You or others may be thrown from the boat.
- Children and nonswimmers must wear a life jacket at all times.
- Never leave children in the boat without adult supervision.
- Improper operation of the boat is extremely dangerous.
- Securely attach the engine emergency stop switch lanyard to a part of your clothing, such as a belt loop, when operating the boat.
- Operate slowly in congested areas such as marinas and mooring areas.
- The bow may be slippery. Do not go forward while the engine is running.
- Slow down when crossing waves or a wake in order to minimize the impact on the passengers and the boat.
- Never dive from the boat without being absolutely sure of the depth of the water; severe injury or death may occur from striking the bottom or submerged objects.

- Never swim near the boat when the engine is running. Even if the boat is in the NEUTRAL position, the propeller may still be turning and carbon monoxide may be present.
- Watch for other boats, swimmers and obstructions in the water. Stay away from other boats and personal watercraft.
- Never replace your boat's marine parts with automotive parts (if applicable).
- Never remove or modify any components of the fuel system. Always have qualified personnel perform fuel system maintenance. Tampering with fuel components may cause a hazardous condition.
- Avoid contact with engine exhaust gases.
- Engine exhaust contains carbon monoxide.
- Never operate the engine in a confined space.
- Never go under the boat cover with the engine running or shortly after the engine has been running.
- Allow adequate ventilation with fresh air before entering any enclosed areas.

### TOW BOAT SAFETY

Avoid an incident by being completely knowledgeable about your boat, its operation, the additional equipment you use, and the waterway you are using, and learn to recognize potentially hazardous situations. Maintain control of your boat at all times. Keep a sound mind during an emergency and always think safety. Use caution and common sense when operating your boat. Don't take unnecessary chances!

Likewise, persons being towed must know the signals, maintain situational awareness of their surroundings and practice safe starting, boarding, skiing and stopping practices. No matter your ability, the enjoyment of towed water sports can quickly turn into an emergency situation if the precautions are not observed.

Failure to follow and adhere to warnings may result in severe injury or death to you and/or others.

### Water Sports Safety Code

**Before you get in the water:** Skiing or riding instruction is recommended before use. Instruction will teach general safety guidelines and proper skiing or riding techniques, which may reduce your risk of injury. For more information on skiing or riding schools, contact your dealer, Association or local ski club.

- Know the federal, state and local laws that apply to your area.
- If you are not familiar with a waterway, ask someone who is knowledgeable to tell you about any hidden dangers or things to avoid.

- Whether you plan to be in a watercraft or skiing/riding behind one, it is important you are wearing a properly fitted life jacket (PFD) approved by your country's agency, United States Coast Guard (USCG) Type III, International Organization for Standardization (ISO), etc.
- Inspect all equipment prior to each use: check bindings, fins, tube, attachment, tow rope and flotation device. Do not use if damaged.

**Watercraft safety:** A knowledgeable and responsible driver along with a separate observer is the most important safety device on any watercraft.

- Never operate a watercraft, ski or ride under the influence of alcohol or drugs.
- Only use water ballast and people for additional weight.
- Never exceed the passenger or weight limitations of the watercraft.
- Never allow passengers to hang outside the watercraft or towed device or sit on the gunwales or anywhere outside of the normal seating area.
- Never allow water to overflow the bow or gunwales of the watercraft.
- Uneven weight distribution or additional weight may affect the handling of the watercraft.

**Carbon monoxide:** The exhaust from the engine on a watercraft contains carbon monoxide (CO), which is a colorless, odorless and poisonous gas. Excessive exposure to CO can cause severe injury or death. Follow this advice to avoid injury.

- Never "Platform Drag" by holding onto the boarding platform or being dragged directly behind the watercraft. This is where CO will be.
- Do not sit on the watercraft transom or boarding platform while the engine is running.
- Make sure the engine is properly tuned and running well. An improperly tuned engine produces excessive exhaust and CO.
- If you smell engine exhaust do not stay in that position.
- Go to the USCG's website ([www.uscgboating.org](http://www.uscgboating.org)) for more information on how to help protect yourself and others from the dangers of CO.

**Tow ropes:** Tow ropes come in different lengths and strengths for different activities. Make sure any rope you are using is suited for that activity and that it is in good condition.

- Never use a rope that is frayed, knotted, unraveling or discolored from use or being left in the sun. If a rope breaks while in use, it can recoil at the skier/riders being towed or into the watercraft where it might strike passengers. Replace tow ropes with any sign of damage.
- Never use a tow rope with elastic or bungee material to pull skiers or riders
- Rope should be attached to the watercraft in an approved fashion with hardware designed for towing. Refer to your watercraft manual for instructions on proper tow rope attachment.
- Always keep people and tow ropes away from the propeller, even when idling.

## Section 3

- If a tow rope should become entangled in a propeller, shut off the engine, remove the key and secure it in a safe location before retrieving the rope.
- Tow ropes should be neatly stowed in the boat when not in use.

**Preparing to ski or ride:** Always have a person other than the driver act as an observer to look out for the skier/rider.

- Be sure the driver is aware of the experience and ability level of the skier/rider.
- The driver, observer and skier/rider need to agree on hand signals before skiing or riding. Signals should include READY, STOP, SPEED UP and SLOW DOWN.
- Start the engine only after making sure that no one in the water is near the propeller.
- **Turn off the engine when people are getting into or out of the watercraft, or in the water near the watercraft.**
- Always make sure the tow rope is not wrapped around anyone's hands, arms, legs or other parts of the body.
- Start the watercraft and move slowly to remove slack until the tow rope is tight.
- When the skier/rider signals READY (Hit It) and there is no traffic ahead, take off in a straight line. Adjust the speed according to the signals given by the skier/rider.

**Skiing or riding:** The watercraft and skier/rider should always maintain a sufficient distance from obstacles so a skier/rider falling or coasting and/or watercraft will not encounter any obstacle.

- Do not use in shallow water or near shore, docks, pilings, swimmers, other watercraft or any other obstacles.
- Use only on water.
- Never attempt land or dock starts or stops. This will increase your risk of injury or death.
- Always wear a properly fitted life jacket approved by your country's agency, USCG Type III, ISO, etc. Consider investing in specialized ski clothing and a competition life jacket for added safety.
- The faster you ski or ride, the greater your risk of injury. The skier/rider should be towed at an appropriate speed for his or her ability level.
- Never make sharp turns that may cause a slingshot effect on the skier/rider's speed.

**Fallen skier or rider:** Falling during water sports is commonplace and injuries from a variety of causes can occur.

- If the skier/rider does not immediately indicate that they are "OK", assume that they need assistance.
- Circle a fallen skier/rider slowly to return the tow rope handle or pick up the fallen skier/rider.
- **Turn off the engine** when near a fallen skier/rider.

- Always keep the fallen skier/rider in view and on the driver's side of the watercraft
- Display a red or orange skier-down flag to alert other vessels that a skier/rider is down if required by the state in which you are operating.

**The warnings and practices in the Water Sports Safety Code represent common risks encountered by users. The code does not cover all instances of risk or danger. Please use common sense and good judgment. These concepts are explored in greater depth in the pages that follow.**

## Water Sport and Towing Safety

Boat operators, skiers and boarders must all be aware of current boating and water sport rules and pay constant attention to safe operating procedures and skiing practices at all times. If skiing or boarding is a new sport to you, seek certified training before starting. Be sure to thoroughly read all information provided by the water sport equipment manufacturer.

Always remember that the majority of water sports injuries are the result of impacts with other objects. Know the area you are boating in.

Always maintain clear vision where you are going and be aware of what is going on around you. Constant vigilance will go a long way toward preventing accidents. Skiers, boarders and other water sports participants must always wear a USCG-approved life jacket. It's the law!

## Platform Dragging

Read, understand and be familiar with the information contained on warning labels on the boat and on the water sports equipment used, and adhere to the safe operation practices on them. The USCG issued a SAFETY ALERT on August 28, 2001 that covers some of the issues of improper use of the boarding platform.



**DANGER**

### **CO / PROPELLER INJURY ACCIDENT**



“Platform Dragging” places the individual in a position directly exposed to the CO in the engine’s exhaust. It is the equivalent of dragging directly behind the bumper of a truck on roller skates. This may result in a loss of coherent responses and even death. In addition, “Platform Dragging” dangerously exposes the individual to a possible propeller injury.

### Propeller Strikes

Recreational boating has become even more popular in the last several years, and the types of injuries that can occur from unsafe boating have increased. These injuries include exposure to CO, rotating parts or hot engine components. Injuries such as these are dangerous and add to the belief that boating can be unsafe. Knowledge and taking precautions before boating can increase safety on the water and provide a lifetime of boating enjoyment.

Boat manufacturers and safe boating agencies strive to keep boating and water sports as safe as possible by providing guidelines. Still, it is the boating enthusiast's responsibility to follow these guidelines. The responsibility of the operators, participants or bystanders is to protect themselves from danger by observing warnings and keeping all safety equipment in place and ready to use.

Contact with rotating propellers is one of the most dangerous hazards, which occurs from negligence of operators, passengers and bystanders. A propeller is designed to travel in the water and rotates at a speed that can cause death if it comes into contact with a human. Severing, deep lacerations, blood loss, trauma and exposure to microorganisms in the water that enter the bloodstream can result in death or serious injury.

#### **STOP PROPELLER STRIKES by always using caution and:**

- **OBSERVING** all warnings and keeping all safety equipment in use and in place.
- **STOPPING** the engine when swimmers are near the boat and in the water.
- **MAKING SURE** all passengers are seated on a horizontal seat cushion whenever the boat is in gear or moving.
- **NOT ALLOWING** passengers to enter the water when the engine is running.
- **USING** the boat's emergency stop switch at all times.
- **MAKING SURE** all operators are properly trained and qualified to operate the boat.
- **KEEPING** your eyes on your path as well as the water sports participant.
- **NOT ALLOWING** water sports participants to be in the path of other boaters.
- **STAYING CLEAR** of swimmers and other water sports participants by maintaining visual surveillance.
- **KNOWING** the correct water sports hand signals.
- **NOT ALLOWING** children under 11 years of age to occupy the open bow area unless accompanied by an adult.
- **USING** an observer during water sports activities.



## Water Sports Responsibility Code

### BE AWARE

There are risks in boating and water sports that good judgment and personal awareness can help reduce. To increase your enjoyment of water sports, follow the ten elements of the Code.

In water sports, it is your responsibility to:

- ALWAYS familiarize yourself with applicable laws, waterways and inherent risks.
- ALWAYS have a capable observer in addition to driver, and agreed on hand signals.
- ALWAYS wear a properly fitted life jacket approved by your country's agency.
- ALWAYS read user's manual and inspect equipment before use.
- ALWAYS ski and ride under control, at proper speeds, and within your limits.
- ALWAYS turn ignition off when anyone is near watercraft power drive unit.
- ALWAYS stay clear of engine exhaust to avoid carbon monoxide poisoning.
- NEVER "Platform Drag" or touch swim platform while the engine is running.
- NEVER ski or ride near swimmers, shallow water, other boats or obstacles.
- NEVER operate watercraft, ski or ride under the influence of alcohol.

### Know Water Sports Hand Signals

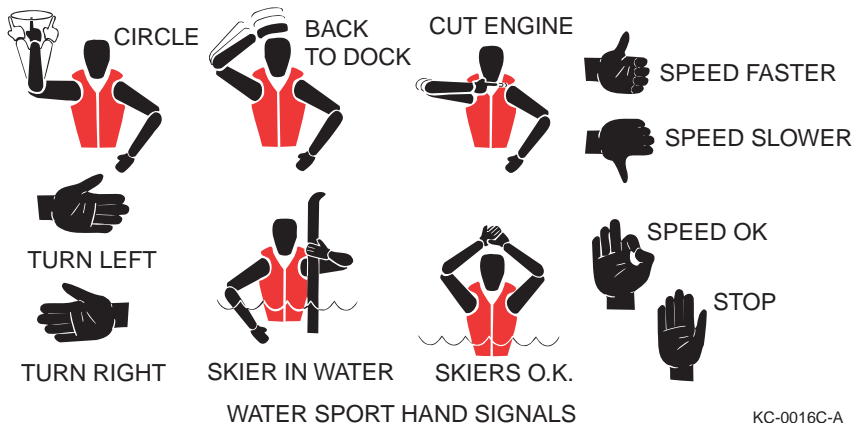

Figure 3-1

### Falling Tips for Water Sports

- Sudden falls happen. DO NOT put any body parts (arms, legs, head) inside the rope handle.
- Tighten your life jacket straps for a snug fit.

## Section 3

- Let the handle go as soon as you sense you're about to fall. Falling is better than dragging.
- Roll with it. Bow your head, bend your knees, tuck in your arms and make like a beach ball.
- Signal the observer to let them know you are OK after a fall.
- After you fall, lift your ski or board above the water so other boaters can see you.
- When learning advanced maneuvers, it's best to seek training from a professional.
- A little advice will cut down on falls, shorten your learning time and reduce the chances of an injury.

### Driver - Best Practices

#### BE AWARE

**Many water sports boats are at home in calmer waters due to the design of the hull. Avoid large bodies of open water with the risk of severe chop in water sports boats.**

The boat driver plays a critical role in the enjoyment and safety of all towed water sports participants. Do not allow inexperienced drivers to drive for skiers/riders without thorough instruction and training. We encourage all boat operators to take a boater's education course. See your state's boating authority for available courses or other operating requirements.

- Wait for a clear boat path ahead of you before accelerating.
- Make sure to use the proper rope for the sport. A rope designed to pull a skier is not the recommended rope for towing a tube.
- If skiing, boarding or tubing with more than one person, make sure all tow ropes are the same length.
- Keep a 100-foot buffer zone on all sides of the boat and stay in water that is safe for the skier/rider and draft of your boat.
- Make sure the tow line unwinds smoothly without getting snagged on anyone or anything.
- Idle forward to make the rope tight.
- Accelerate only when the tow rope is completely tight and the skier/rider has given the "hit it" signal. The words GO and NO can be easily confused with wind, water and engine noise all around you. It is best to find another signal other than GO to tell the driver to power up. HIT IT or BOAT DRIVER are better options.
- Always approach fallen skiers/riders in the water from the driver's side, so the driver does not lose sight of them.
- **TURN OFF ENGINE** when a skier/rider is near the boat, rather than running the engine in NEUTRAL. An accidental bump of the throttle when the engine is running could put the boat in gear.

- DO NOT let the tow rope slip under the boat and become tangled in the propeller. It is a good practice to keep a knife on board should this situation occur.
- Always pay attention to the water ahead, the traffic around you and your onboard observer. Your observer must always keep you aware of the skier/rider status.
- DO NOT whip skiers or riders near shores, docks, other boats or fixed obstructions; they can glide 100 feet or more after they let go of the rope.



## DANGER

### Entanglement Hazard



Accelerating before the rope is 100% tight, and the skier/rider gives the “HIT IT” signal, can result in skiers/riders becoming entangled in the rope. Entanglement in the rope can result in severe injuries or death.

### Driving Pattern

Drivers who want to minimize the rough water for the skier/rider should utilize a dog-bone pattern when driving. A dog-bone pattern follows the same path from one end of the course to the other, with tight controlled turns at each end. Use this pattern where few other boats are operating. In areas where many boats are operating, use a large racetrack pattern.

Check with local lake laws before you drive any pattern. Some areas require drivers to drive skiers/riders in preset patterns.

**Use in light traffic areas**

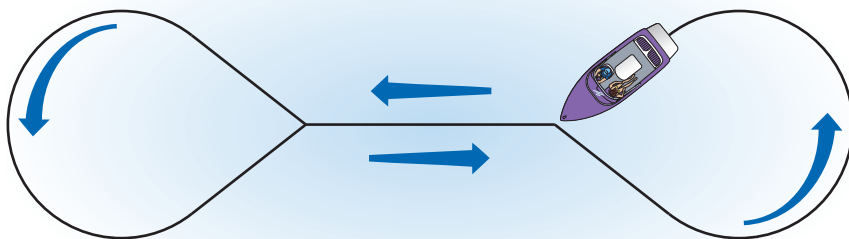

KC-0317C-A

Figure 3-2

## Use in heavy traffic areas

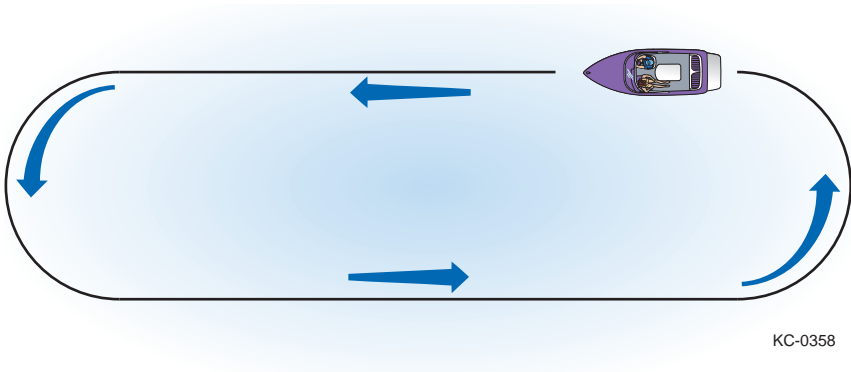

**Figure 3-3**

### Driver Position

1. Always keep your right hand on the throttle, even if you have a speed control device engaged, so you have immediate control of the throttle.
2. Always keep your left hand on the steering wheel, preferably at the 10 o'clock position. If you take it off, the light-pressure steering you enjoy becomes sensitive to even small torques on the rudder. This could cause the boat to take unexpected turns.
3. Sit firmly in the driver's seat, never on the seat backs, gunwale, sun deck or anywhere else where one big wake could eject you from the craft.
4. Alternate your eyes between the mirror, to watch the skier/rider, and your boat path. Watching your wake in the mirror can help ensure a straight boat path. Continually watch all directions for boats or other obstructions
5. Monitor the gauges, including water temperature and oil pressure, to make sure the engine is running smoothly. Keep the fuel gauge over 1/4 tank to prevent sloshing gas giving a false reading.
6. It is the driver's responsibility to keep all passengers seated in a proper seat while the boat is underway. **DO NOT** allow passengers to sit on the seat backs, gunwale, sun deck or motor box. Sitting in these positions will often encourage a visit from your local water patrol, and may result in a ticket. **DO NOT** allow small children to sit in the bow area when the boat is under way without adult supervision.

## Water Sport Tips

These tips are designed to help speed your learning, while ensuring safety. Practice, training from a professional and advice from experienced boaters are the best tools for learning safety when it comes to water sports.

**REMEMBER: It's important to follow the manufacturer's recommendations for the intended use of the water sport equipment.**

**REMEMBER: It is illegal in many states to participate in towed water sports without a USCG-approved life jacket.**

### BE AWARE

**You are responsible for your own wakes. Be considerate of other boaters, especially small fishing boats, canoes and kayaks that can overturn easily. Also, be aware of your wakes in relation to swimmers, docks and boats tied to docks.**

## Water Skiing

A rush of acceleration as you cut across the wakes will cause you to go faster than the speed of the boat. You can slice it up in open water, or navigate the slalom course if you want to track your progress in the competitive side of the sport.

When water skiing, keep the following tips in mind:

- **Speed:** Faster than wakeboarding, but still only requires about 20-24 mph on combo skis or a shaped slalom ski. More advanced slalom skiers can go anywhere from the mid 20s to a top speed of 36 mph.
- **Line length:** 75 feet is a good place to start, but adjust it accordingly to find the mellowest, most ski-friendly part of the wake on your boat. Serious skiers obsess over taking that line length ever shorter, while still attempting to reach the buoys in a slalom course.
- **Driving tips:** Guide the boat straight, since today's towboats handle almost like on a rail. Speed controls also promote consistent speeds. Follow the same path back and forth to stay on the smoothest water. Drivers should hold speed commensurate with the level of the skier.
- **Ballast:** Equal weight means equal wakes. If you're a 175-pound driver, make sure you have a balanced load on the opposite side (a 125-pound passenger with 50 pounds of ballast, etc.). Lighten the load in the back of the boat to prevent the hull from digging in, creating larger-than-intended wakes.

**Deep water start:** Go into a crouched position, with combo skis or slalom ski underneath you and legs very bent. Point the ski tip out of the water toward the boat. Don't worry if a slalom ski isn't straight up and down. Keep part of it touching the tow rope, then as the boat starts, it will correct itself and center along the tow-rope line.

## Section 3

With arms straight, and knees bent, let the boat pull you up and onto the water, rather than pushing on the ski or leaning back against the pull.

**What to do next:** After the driver and the skiers have their fill of casual skiing in open water, try driving straight down the middle of a slalom course as the skier swings back and forth around special turn buoys. It's addictive.

For more detailed and comprehensive instruction and additional ideas, visit: Basic Skills Challenge series:

<http://www.usawaterski.org/basicskillschallengeseries.htm>. Instructional articles can be viewed at: <http://www.usawaterski.org/pages/instruction.html>.

### Wakeboarding

Go anywhere, do anything in a pure adrenaline rush. There's always a fun new move to learn. It's a sport you can make your own, by adding your own style to any trick.

**When wakeboarding, don't forget your:**

- **Speed:** For the first time with kids, 12 mph; around 18-24 mph for adults. Accelerate slightly if you need to adjust the wake so that it has a clean edge (not foamy) near the front foot of the rider.
- **Line length:** 65 feet is a good length for beginners, who will appreciate being back where the wakes are softer and farther apart, though many riders start at around 50 feet (the shorter rope length can make it easier to get up). More experienced riders may want to be at about 75-80 feet, where the wakes are more defined and wider.
- **Driving tips:** Drive straight to establish consistent wakes for the rider to enjoy. The observer should always be facing the rider so the driver can focus on that path and the speed. Slow but steady acceleration is best for wakeboarding
- **Ballast:** Factory-installed systems allow you to safely add hundreds of pounds of water weight in ideal spots on the boat and shape the wakes for each rider's preference. Weigh down the stern equal to the bow to best maintain your boat's handling, taking into account passenger seating. A water-filled ballast bag is the best way to add weight. **DO NOT USE** ballast that sinks, such as a bucket of concrete, or lead.



**WARNING**

#### **OVERLOADING HAZARD**



Empty the ballast system before trailering your boat. The extra weight of ballast water may overload the capacity of your trailer and cause an unsafe condition that can lead to an accident, injury or death.

Always stay within Coast Guard recommendations for your boat's weight capacity. When adding aftermarket ballast systems, maximum boat load capacity **MUST BE** reduced. Reduce passengers and/or equipment by the additional weight of water intended to be taken into the ballast system.

**To help prevent the spread of invasive species, DO NOT transport lake water in your ballast system from lake to lake.**

**What a wakeboarder does first:** Keep knees bent, arms straight, shoulders back and both feet under you on the board (this will result in the long axis of the board being perpendicular to the tow rope). Look straight ahead (not at your feet) and keep the handle low at your front hip as you let the boat pull you out of the water. As you rise onto the water, the board will automatically rotate to be in line with the tow rope. Now you can stand up, with knees still bent slightly, keeping your weight equal over both feet. Let your upper body stay motionless, with shoulders level and perpendicular to the tow rope.

**What to do next:** Cross the wake slowly, but staying on edge to get a feel of how to use the wake as a launch ramp for larger moves. Jump wake to wake to build your confidence. (It is often helpful to shorten the rope when learning this, as the wakes are narrower.)

For additional information visit: <http://www.thewwa.com/about/> or <http://www.usawaterski.org/BasicSkills/LearnToWakeboard.pdf>

## Wakeskating

While wakeboarding is similar to snow-boarding in that the rider's feet are physically strapped to the board, wakeskating brings the spirit of skateboarding to the water (sans wheels). Unleashing an arsenal of skate moves, you're never tied down.

When wakeskating, keep the following tips in mind:

- **Speed:** Ease off a little from wakeboarding speeds to keep the speedometer in the mid-teens.
- **Line length:** This can vary, but start with 65 feet to see how it works for you.
- **Driving tips:** Again, like wakeboarding, follow a straight path for consistent wakes. What a wakeskater does first: Put the board under your feet under the water; then pretend you're sitting down with bent knees. As the boat starts forward, the board will rise onto the water as you stay crouched to set your balance. Stand up, with knees still slightly bent, eyes ahead and your hands near your forward hip. Riders often wear tennis shoes or wakeskate shoes for better traction on the board.

**What to do next:** Try a world of moves, anything from an "ollie" to a "pop shuvit" to a "kick flip" to riding rails. New maneuvers are constantly being invented in this new sport.

## Section 3

**Helmets:** Because a wakeskate is not attached to your feet, it can impact your head or other body parts in a fall. Helmets are strongly recommended when wakeskating.

### Inflatables

Towed inflatables commonly called “tubes,” come in all shapes and sizes now, from traditional doughnuts to rocket-ship cones. It’s all so you and your friends can enjoy a new thrill or a relaxing ride.

When tubing, keep the following tips in mind:

- **Speed:** 8 mph for small children; 20 mph is about the limit for adults. Settle in at 15-18 mph for a safe yet adrenaline-pumping ride. **Don't forget your life jacket** – falls can take your breath away on a tube.
- **Line length:** 60 feet can give you the best of all worlds, close enough to the boat for a sense of control yet far enough for the feeling of freedom on the rampy wakes. Be sure to use a specifically designed tube rope made to support the weight and drag of a tube and the number of people riding the tube.
- **Driving tips:** A leisurely “S” shape gives tubers who can't really control their own motion the chance to swing across the wakes and travel side to side without the need for wild spins and hairpin turns. Slowing the boat down when approaching large wakes can keep inexperienced riders from getting thrown from the tube when they are not ready for it.

**What a tuber does first:** Start on a big family-friendly traditional shape, introducing the kids and friends to tubing. Lie on your stomach to plant yourself firmly on the tube, and hang on to the handles.

**What to do next:** Grab a new shape with extra-big handles to hang onto; then find a lot of open water, turn some bigger “S” turns and “let loose,” without letting go, of course.

**REMEMBER:** It's important to follow the manufacturer's recommendations for inflation, as well as the intended use of the water sport equipment.



**DANGER**

### Entanglement Hazard

Never accelerate the towboat or watercraft unless the tow rope is completely tight. Failure to follow this warning can result in rope burns, loss of limbs or even death.





## Barefooting

There's nothing like the sensation of "walking" on water. Since your feet have less surface area than a ski or board, so you'll need to go faster and be more cautious. Because of the speeds involved, the extra protection of neoprene ski vest and shorts in addition to a competition-grade life jacket are highly recommended.

**When barefooting, keep the following tips in mind:**

- **Speed:** A general guideline for speed is the barefooter's weight divided by 10 then add 20. A 150-pound person would go approximately 35 mph. Those faster speeds, usually ranging from 30 to 45 mph, require extra caution, especially with knowing how to fall and looking out for debris in the water.
- **Line length:** 100 feet, use the length to get back to the calmer water.
- **Driving tips:** It takes finesse to manage just the right gradual (but not too strong) acceleration to get a barefooter out of the water, then a steady throttling-up to climb to footing speed.

**What a barefooter does first, three ways to get going:**

1. Start on a kneeboard or a wakeskate in a forward-seating position and slowly come up to speed to plane while setting your feet in the water slowly.
2. Step off a single slalom ski.
3. If you really want to shorten the learning curve, find an experienced instructor with a boom attached to the boat.

To stay on the water, have your feet shoulder-width apart and your knees bent at a right angle. Position your feet forward of your body; some experimentation of feet position will be necessary before you find the "sweet spot."

**What to do next:** Don't just stand still, move! Learning to shift your weight and the handle leads to fun maneuvers such as one-foot wake crossings, tumble-turns and jumps.

For additional information visit:

<http://www.usawaterski.org/pages/divisions/barefoot/main.htm> and

<http://www.usawaterski.org/BasicSkills/LearnToBarefoot.pdf>

## Wakesurfing

Water lovers with ocean envy are getting hooked on wakesurfing, creating their own mini waves with their boats.

When wakesurfing, keep these tips in mind:

- **Speed:** Relatively slow, about 10 mph to churn up surfable wakes without outrunning the surfer.

## Section 3

- **Line length:** Start with 10-15 feet behind the platform to put you onto a beefy section of the wake, but far enough back to get you as clear as possible from the platform of the boat. Make sure to use a rope designed for wakesurfing. Wakesurf ropes offer a thick braid that is easier to pull yourself into the proper spot on the wake.



### CAUTION

#### ENTANGLEMENT HAZARD



**DO NOT** use the thin, non-stretch ropes intended for wakeboarding. Thin ropes can be dangerous when you are pulling yourself into the wake.

- **Driving tips:** Adjust ballast and passengers to favor the stern, but not so much to risk taking on water. Keep straight and steady with no sudden slowdowns. A slight turn toward the side the rider is on can help shape the wakes better for surfing on some boats. Each boat is different here, so experiment with different things to make the wakes as good as possible

**REMEMBER:** Never use the gunwales for seating. Doing this is dangerous and most water patrols will ticket you for this behavior.

- **Ballast:** Factory-installed systems allow you to safely add hundreds of pounds of water weight in ideal spots on the boat and shape the wakes for each rider's preference. Weigh down the stern equal to the bow to best maintain your boat's handling, taking into account passenger seating. A water-filled ballast bag is the best way to add weight. **DO NOT USE** ballast that sinks, such as a bucket of concrete, or lead.



### WARNING

#### OVERLOADING HAZARD



Empty the ballast system before trailering your boat. The extra weight of ballast water may overload the capacity of your trailer and cause an unsafe condition that can lead to an accident, injury or death.

Always stay within Coast Guard recommendations for your boat's weight capacity. When adding aftermarket ballast systems, maximum boat load capacity **MUST BE** reduced. Reduce passengers and/or equipment by the additional weight of water intended to be taken into the ballast system.

To help prevent the spread of invasive species, **DO NOT** transport lake water in your ballast system from lake to lake.

**What a wakesurfer does first:** Figure out which wake, the left or the right, offers the most natural riding for you and the best definition. Most riders ride "toes in" to the wake. Keep your knees very bent, and your rope very low as you start. Ride into the wall on the wake until you feel the wake push you, without any pull on the rope. At that point, the rider can throw the rope back into the boat, and surf with total freedom.

**What to do next:** Create your own fusion of skate, wakeboard and surf moves.



## DANGER

### Entanglement Hazard



Surfers will often experiment with rope length to find the sweet spot on the wake. **Never coil excess rope around your hands or arms while wakesurfing. Always throw the rope away from your body in a fall. A fall into a coiled rope can cause severe injury to any extremity.**

## SAFETY DECALS AND STATEMENTS

### Safety Decals

Your boat is affixed with various hazard and safety decals at the time of manufacture. These decals appear in specific locations on the boat and on equipment where safety is of particular concern. Hazard and safety decals must remain legible. If you suspect a decal is missing or one becomes damaged, contact your dealer for immediate replacement.

Part Number	Location
78-15 vend	Inside rear ski locker
78-8 vend	Inside rear ski locker
78-6 vend	Inside rear ski locker
78-173 vend	Inside rear ski locker
78-181 vend	Port rear transom
78-180 vend	Port observer seat walk thru panel
78-141 vend	Port observer seat walk thru panel
78-184 vend	Port observer seat walk thru panel
78-304 vend	Port observer seat walk thru panel
78-302 vend	Port observer seat walk thru panel
78-214 vend	Helm above stbd screen
78-184 vend	Bow center seat base
72-15 vend	Stbd inside windshield
78-167 vend	Inside stbd tower base
78-163 vend	Port rear tower center section
78-168 vend	Stbd rear tower center section
78-16 vend	Above port & stbd gas fill
78-210 vend	Above port & stbd gas fill
72-14 vend	Inside stbd rear hatch

## CAUTION CHECK LIST

For maximum enjoyment and safety, check each of items BEFORE you start your engine:

- ✓ DRAIN PLUG (Securely in place)
- ✓ LIFE SAVING DEVICES (One for every person on board?)
- ✓ STEERING SYSTEM (Working smoothly and properly)
- ✓ FUEL SYSTEM (Adequate fuel? Leaks? Fumes?)
- ✓ BATTERY Fully charged? Cable terminals clean and tight?)
- ✓ ENGINE (In neutral?)
- ✓ CAPACITY PLATE (Are you overloaded or overpowered?)
- ✓ WEATHER CONDITIONS (Safe to go out?)
- ✓ ELECTRICAL CONDITIONS Lights, horn, pump, etc.?)
- ✓ EMERGENCY GEAR (Fire extinguisher, bailer, paddle, anchor & line, signaling device, tool kit etc.?)
- ✓ INSPECT BILGE PUMP (Will water exit boat and is pump free of debris?)

CNTRN-0050B-A

*Figure 3-4*

**⚠ DANGER**



**Carbon monoxide (CO) can cause brain damage or death.**

Engine and generator exhaust contains odorless and colorless carbon monoxide gas.

Carbon monoxide will be around the back of the boat when engines or generators are running.

Move to fresh air, if you feel nausea, headache, dizziness, or drowsiness.

NY-006-07

CNTRN-0053C-A

**⚠ WARNING**

ROTATING PROPELLER MAY CAUSE SERIOUS INJURY OR DEATH. DO NOT APPROACH OR USE PLATFORM WHEN ENGINE IS RUNNING.

CTNB78-174

**⚠ WARNING**

**GASOLINE VAPORS CAN EXPLODE. BEFORE STARTING ENGINE OPERATE BLOWER FOR 4 MINUTES AND CHECK ENGINE COMPARTMENT BILGE FOR GASOLINE VAPORS.**

CTNB78-214

**MEETS U.S. EPA EVAP STANDARDS USING CERTIFIED COMPONENTS**  
FINELINE IND., MERCED, CA

CTNB78-212

**"EPA fuel vent recovery system requires boat to be in a level static position to allow maximum refueling capacity. Bow up or down will reduce refueling capacity."**

CTNB78-210

**WARNING**

LEAKING FUEL IS A FIRE AND EXPLOSION HAZARD. INSPECT SYSTEM REGULARLY. EXAMINE FUEL TANKS FOR LEAKS OR CORROSION AT LEAST ANNUALLY.

CNTRN-0046C-A

**⚠ WARNING**



**Carbon monoxide (CO) can cause brain damage or death.**

Engine and generator exhaust contains odorless and colorless carbon monoxide gas. Signs of carbon monoxide poisoning include nausea, headache, dizziness, drowsiness, and lack of consciousness.

Get fresh air if anyone shows signs of carbon monoxide poisoning.

See Owner's Manual for information regarding carbon monoxide poisoning.

NY-006-07

CTNB78-180

**WARNING**

If you smell exhaust at anytime, remove yourself from that area immediately. Exhaust can carry Carbon Monoxide that can cause injury or death.

CNTRN-0048C-A

**ATTENTION**

**DO NOT OPERATE MULTIPLE ELECTRICAL OPTIONS SIMULTANEOUSLY WITHOUT ENGINE RUNNING (IN WATER) OR SYSTEM MAY OVERLOAD.**

CNTRN-0056C-A

**FINELINE INDUSTRIES INC. ASSUMES NO LIABILITY FOR PERSONAL INJURY OR PROPERTY DAMAGE RELATING TO THE USE OF ANY WATER SKI TOWING DEVICE INSTALLED ON THIS BOAT. THIS INCLUDES BAREFOOT BOOMS, TRICK RELEASES, PYLON EXTENSIONS OR RELATED APPARATUS.**

CNTRN-0040C-A

CNTRN-0058C-A

Figure 3-5

**CAUTION**  
 DO NOT OPERATE BALLAST SYSTEM WITHOUT WATER FLOWING THROUGH PUMP AS PUMP PROPELLER MAY BE DAMAGED CAUSING PUMP TO OVERHEAT  
 DO NOT OVERFILL BALLAST TANK

CNTRN-0044C-A

**CAUTION**  
 THE ENGINE BLOCK MAY OR MAY NOT HAVE BEEN DRAINED AT FACTORY.  
 TAKE ALL MEASURES APPROPRIATE TO INSURE PROPER WINTERIZATION.

CNTRN-0045C-A

**CAUTION**  
 DO NOT ENTER OR EXIT COCKPIT WHILE ENGINE IS RUNNING.  
 TOP FUEL PRIOR TO EACH OPERATION.  
 DO NOT OPERATE AFTER SUNSET OR BEFORE SUNRISE.  
 CHECK OIL AND TRANSMISSION LEVELS PRIOR TO EACH OPERATION.  
 IF LOW OIL OR HIGH TEMPERATURE LIGHT COMES ON, STOP OPERATIONS AND CONSULT DEALER.  
 USE CAUTION FOR PROPELLER UNDER BOAT.

CNTRN-0052C-A

Owners responsibility to comply with any and all local on state decorative lighting regulations, and USCG navigation lighting regulations.

78-302

**OWNERS RESPONSIBILITY TO TIGHTEN SKI PYLON**

CNTRN-0043C-A

**CAUTION**  
 SKI LOCKER MUST BE LOCKED WHEN BOAT IS MOVING, OR DAMAGE MAY OCCUR

CNTRN-0042C-A

**BOW SECTION LIMIT**  
**2 PERSONS OR 370 LBS.**  
78-101

CTNB78-184

**BATTERY CABLES MUST REMAIN TIGHT AT ALL TIMES**  
 LOOSE CABLES MAY CAUSE IGNITION OR OTHER FAILURE  
 POSITIVE CABLE IS DISCONNECTED AT FACTORY PRIOR TO SHIPPING TO PREVENT BATTERY DISCHARGE FROM LACK OF USE.

CNTRN-0055C-A

**WARNING!** If the sliding seat studs are not in the track do NOT sit on the seat. The seat will fall and you can do harm to yourself and to the boat.

CTNB78-312

CNTRN-0059C-A

Figure 3-6

# Section 3



78-304



CTNB78-301



CTNB78-300

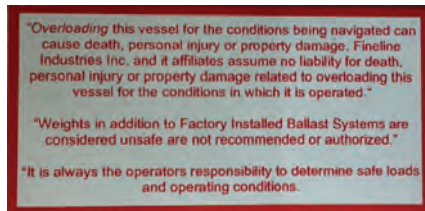

CTNB78-196

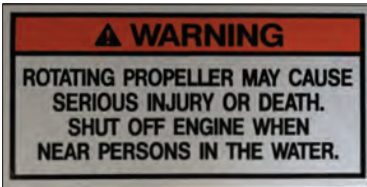

CTNB78-179



CTNB78-168



CTNB78-167



CTNB78-163

CNTRN-0059D-A

Figure 3-7



## Safety Statements

There is no substitute for common sense and careful practices. Improper practices or carelessness can cause burns, cuts, mutilation, asphyxiation, other bodily injury or death. This information contains general safety precautions and guidelines that must be followed to reduce risk to personal safety. Special safety precautions are listed in specific procedures. Read and understand all of the safety precautions before operation or performing repairs or maintenance.



Note: This safety alert symbol appears with most safety statements. It means attention, become alert, your safety is involved! Please read and abide by the message that follows the safety alert symbol.



### DANGER

Indicates a hazardous situation which, if not avoided, *will* result in death or serious injury.



### WARNING

Indicates a hazardous situation which, if not avoided, *could* result in death or serious injury.



### CAUTION

Indicates a hazardous situation which, if not avoided, *could* result in minor or moderate injury.

### NOTICE

*Used to address practices not related to personal injury.*

## Safety Precautions



The safety messages that follow have DANGER level hazards.

These safety messages describe hazardous situations which, if not avoided, *will* result in death or serious injury.

**Do not permit anyone to launch, operate or retrieve your boat without proper training.**

- Read and understand this operator's manual and all manufacturer-supplied information before you operate or service your boat to ensure that you follow safe operating practices and maintenance procedures.
- Safety signs and decals are additional reminders for safe operating and maintenance techniques.
- See your authorized boat dealer for additional training.

### Exhaust Hazard

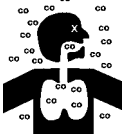

**Carbon monoxide (CO) is a colorless and odorless gas produced by all engines, fuel-burning appliances, and any material that contains carbon and is burned.**

- Even with the best boat design and construction, plus the utmost care in inspection, operation and maintenance, hazardous levels of CO may still be present in accommodation areas under certain conditions. To reduce CO accumulation, always provide adequate ventilation in the boat interior by opening the deck hatches, windows or canvas.
- Do not confuse carbon monoxide poisoning with seasickness, intoxication or heat stress. If someone complains of irritated eyes, headache, nausea, weakness, dizziness or drowsiness, or you suspect carbon monoxide poisoning, immediately move the person to fresh air, investigate the cause and take corrective action. Seek medical attention if necessary.

### Explosion Hazard



**While the engine is running or the battery is charging, hydrogen gas is being produced and can be easily ignited. Keep the area around the battery well-ventilated and keep sparks, open flames and any other form of ignition out of the area.**

## WARNING

The safety messages that follow have **WARNING** level hazards.

These safety messages describe hazardous situations which, if not avoided, *could* result in death or serious injury.

### **Fire and Explosion Hazard**



**Gasoline is extremely flammable and highly explosive under certain conditions.**

- Do not smoke or allow open flames or sparks nearby when refueling.
- Stop all engines, motors and fans before refueling.
- Maintain contact between the fuel nozzle and the fuel tank or container to prevent electrostatic spark. Do not use a plastic funnel.
- Run the blower (if equipped) to clear the engine compartment of gasoline vapors for at least five minutes **BEFORE** turning on any electrical devices or starting the engine.
- Do not block fuel vents.
- Do not store fuel in any containers or compartments which are not designated for fuel storage and do not use these storage areas for any other purpose.
- Gas discharged by a fire extinguisher system displaces oxygen to smother the fire. If the fire is in the engine compartment, do not open the hatch for at least 15 minutes after the fire extinguisher system operates. Oxygen from the open hatch can feed the fire and cause a flashback.

### **Runaway Boat Hazard**

The engine emergency stop switch and lanyard are extremely important safety devices that must always be used when operating the engine. These safety devices will prevent the boat from becoming a runaway if the operator is accidentally thrown from the seat or away from the helm.

## WARNING

### **Entanglement Hazard**



**Rotating or moving parts can entangle or sever body parts.**

- Do not wear jewelry, unbuttoned cuffs, ties or loose-fitting clothing.
- Tie long hair back when working near moving or rotating parts such as the flywheel or propeller shaft.

## Section 3

- Keep hands, feet and tools away from all moving parts.
- Keep all guards in place when engine is operating.
- Use caution when working with ski or mooring lines so they do not become entangled with the propeller.

### Exposure Hazard



Do not mix cleaning agents together; harmful vapors may be released. Read and follow safety-related precautions found on containers of hazardous substances like parts cleaners, primers, sealants and sealant removers.

### Fire and Explosion Hazard



Hydrogen gases produced by a lead acid battery while it is charging, or the engine is running, can cause an explosion and/or a fire.

Gasoline is extremely flammable and highly explosive under certain conditions.

- Wear personal protective equipment when working on or around batteries.
- Do not smoke or bring a flame near a battery.
- Do not check for a dead battery by placing a metal object between the battery posts. Sparks could cause an explosion.
- Do not place your head directly above a battery when making or breaking electrical connections.
- Charge the battery outside of your boat.
- Do not use a battery booster to start your engine.

## WARNING

### Lifting Hazard

Special equipment is necessary to lift the boat and/or engine. Always use lifting equipment with sufficient capacity to lift your boat and/or engine.

### Alcohol and Drug Hazard



Do not operate your boat while you are under the influence of alcohol or drugs or are feeling ill.

## Exposure Hazard



Wear personal protective equipment, including appropriate clothing, gloves, work shoes, eye and hearing protection, as required by the current task.

## CAUTION

The safety messages that follow have CAUTION level hazards.

These safety messages describe hazardous situations which, if not avoided, *could* result in minor or moderate injury.



Wear eye protection when servicing your boat or when using compressed air or high-pressure water. Dust, flying debris, compressed air, pressurized water or steam may injure your eyes.

## Poor Lighting Hazard

Ensure that the work area is adequately illuminated. Install wire cages on portable safety lamps.

## Tool Hazard

Use tools appropriate for the current task. Use the correct size tool for loosening or tightening machine parts.

## Slip and Trip Hazard



Keep your boat free of water, oil, mud and other foreign matter. Remove anything that creates slippery areas around your boat.

### NOTICE

The safety messages that follow have NOTICE level hazards.

These safety messages are used to address practices not related to personal injury.

#### **Structural Hazard**

Modifications may impair your boat's safety and performance characteristics and shorten the boat's life. Any alterations to your boat may void its warranty.

#### **Environmental Hazard**



ALWAYS be environmentally responsible. Follow the guidelines of the EPA or other governmental agencies for the proper disposal of hazardous materials such as engine oil and fuel. Consult the local authorities or reclamation facility.

## CARBON MONOXIDE

Carbon monoxide (CO) is a colorless and odorless gas produced by all engines, fuel-burning appliances, and any material that contains carbon and is burned. Even with the best boat design and construction, plus the utmost care in inspection, operation and maintenance, hazardous levels of CO may still be present in accommodation areas under certain conditions. To reduce CO accumulation, always provide adequate ventilation in the boat by keeping all areas open and vent enclosures if applicable. **DANGER! Direct and prolonged exposure to CO will cause brain damage or death.**

### Potential Causes of CO Poisoning While Under Way

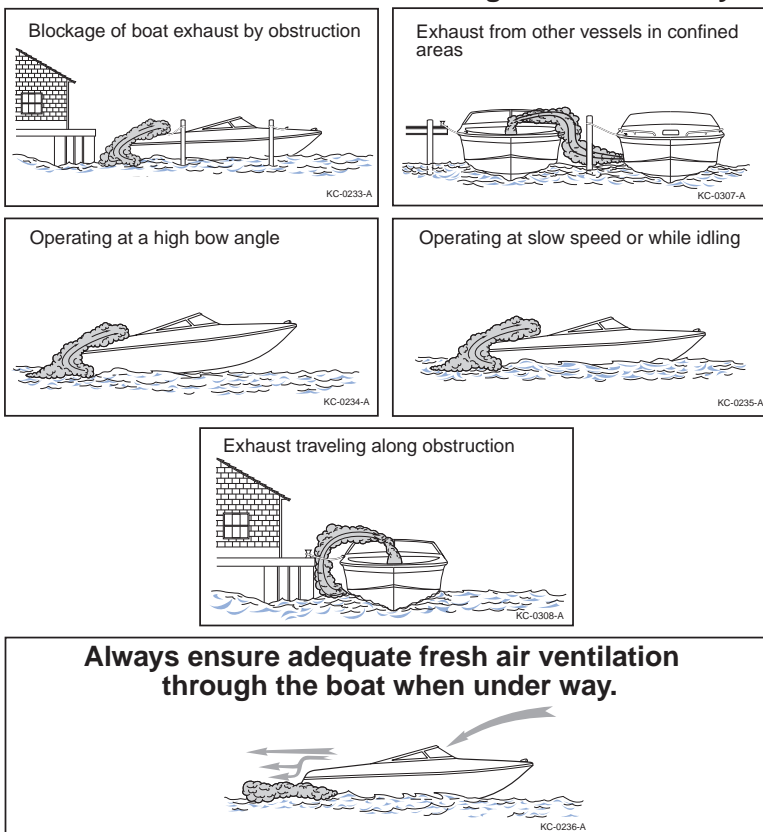

KC-0301-B

Figure 3-8

## REQUIRED BOATING SAFETY EQUIPMENT AND REGULATIONS

### U.S. Coast Guard Minimum On-Board Personal Safety Equipment Required

	Less than 16 ft (4.9 m)	CLASS 1: 16 to less than 26 ft (4.9 to less than 7.9 m)	CLASS 2: 26 to less than 40 ft (7.9 to less than 12.2 m)	CLASS 3: 40 to 65 ft (12.2 to 19.8 m)
<b>LIFE JACKETS AND PERSONAL FLOTATION DEVICES</b>	One Coast Guard-approved Type I, II, III or V wearable life jacket for each person on-board	One Coast Guard-approved Type I, II, III or V wearable life jacket for each person on-board and one throwable Type IV PFD device		
<b>FIRE EXTINGUISHERS</b>	One B-I type (Coast Guard-approved)  If the vessel meets any one or more of the following conditions, the vessel must carry one B-I type USCG-approved extinguisher on-board: <ul style="list-style-type: none"> <li>• Inboard/Sterndrive engine powered</li> <li>• Has closed compartments where portable fuel tanks can be stored</li> <li>• Has double bottom construction that has areas where air or gases can be open or trapped</li> <li>• Has an enclosed living space</li> <li>• Has compartments where flammable, combustible or explosive materials are stored</li> <li>• Has permanent fuel tanks installed</li> <li>• Vessel is 26 ft (7.9 m) or more in length</li> </ul>		One B-II OR two B-I type (USCG-approved) (A fixed extinguishing system is equal to one B-I.)	One B-II AND one B-I OR three B-I type (USCG-approved) (A fixed extinguishing system is equal to one B-I OR two B-II.)
<b>VISUAL DISTRESS SIGNALING DEVICES</b>	One (1) electric distress light OR three (3) day and night combination red flares	One orange distress flag or one electric distress light OR three floating or handheld orange smoke signals and one electric distress light OR three day and night combination red flares, handheld, parachute or meteor type		



	Less than 16 ft (4.9 m)	CLASS 1: 16 to less than 26 ft (4.9 to less than 7.9 m)	CLASS 2: 26 to less than 40 ft (7.9 to less than 12.2 m)	CLASS 3: 40 to 65 ft (12.2 to 19.8 m)
<b>AUDIBLE DISTRESS SIGNALING DEVICES</b>	A vessel less than 39.4 ft (12 m) must have on-board an efficient sound-producing device. (Example: hand or mouth whistle OR a compressed or powered air horn)		A vessel less than 39.4 ft (12 m) must have on-board an efficient sound-producing device. (Example: hand or mouth whistle OR a compressed or powered air horn) A vessel 39.4 ft (12 m) but less than 65.6 ft (20 m) in length operating in inland waterways must carry a power whistle OR powered air horn AND a bell	
<b>NAVIGATION LIGHTS</b>	Regulations require that navigational lights be clearly lit and properly displayed at all times between sunset and sunrise and always when operating in reduced visibility while boating			

## Fire Extinguisher

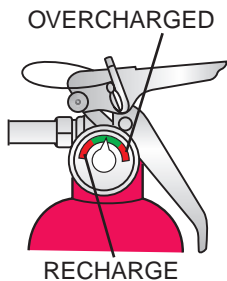

KC-0009C-B

USCG-approved fire extinguishers are required on all Class I, II and III boats. Mount all handheld fire extinguishers in readily accessible areas away from the engine compartment and other combustible devices. All passengers must know the location and operating procedure of each extinguisher. Follow the manufacturer's instructions for proper use and operation of the fire extinguisher.

All fire extinguishers used on marine boats must be classified to extinguish type B fires (gasoline, oil or grease). The size and number of required fire extinguishers depend on the size of your boat. The two type B fire extinguishers commonly used are B-I and B-II. Type B fire extinguishers are classified by the different extinguishing compound amounts used in each.

Check the fire extinguisher condition and pressure gauge regularly, if not before every trip, to ensure that the fire extinguisher is in good operating condition and is fully charged. If the fire extinguisher is damaged or not properly pressurized, replace it.

For specific on-board requirements, see *U.S. Coast Guard Minimum On-Board Personal Safety Equipment Required on page 3-32.*

## Life Jackets

All passengers on Class I, II and III boats must wear a USCG-approved Type I, II, III or V life jacket.

All Class I, II and III boats must have one USCG-approved Type IV throwable Personal Flotation Device (PFD) on-board.

Children and nonswimmers must always wear a life jacket when boating. All life jackets and PFDs must be in a readily accessible area and within immediate reach.

All passengers must know the location of the life jackets and how to wear and adjust them. Follow the manufacturer's instructions for proper use, care and operation of the life jacket.

Each USCG-approved life jacket on-board must:

- Clearly show the manufacturer's name
- Clearly show the USCG approval label and number
- Be an appropriate size and type for each person on-board
- Be in good, usable condition

Selecting the proper life jacket application type and size is important to your safety while boating. There are four application types of wearable PFDs and one type that is used only for throwing in emergency situations. Life jackets may include inherently buoyant designs (do not require inflation) or inflatable (manual and manual with automatic backup). Life jacket sizes generally correspond to chest size and weight.

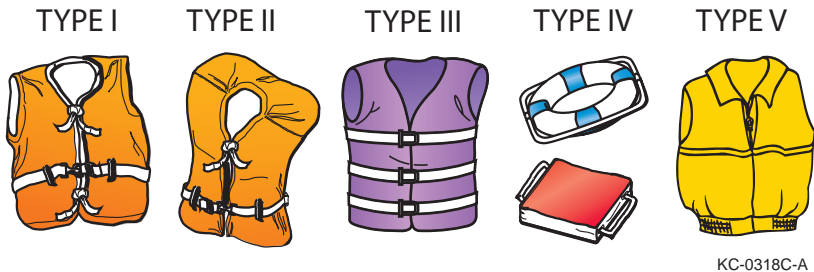

**Figure 3-9**

### Type I

This life jacket is designed so that the person wearing it turns to a face-up position when conscious or unconscious. Type I life jackets are the most buoyant and are effective on all waters, especially when rescue is delayed or flotation time is extended.

## Type II

This life jacket is recommended for use in calm water near shore on most inland waters where quick rescue is likely. A Type II life jacket is similar to a Type I life jacket, but is not as buoyant or effective in turning the wearer to a face-up position. **Type III**

This life jacket is designed for personal buoyancy when the wearer is alert and conscious. Type III life jackets require users to turn themselves to a face-up position. Type III life jackets are recommended in most inland water applications where quick rescue is likely or when used in the presence of other people.

## Type IV

These PFDs are designed to be thrown to a person in the water who can grab and hold it while being rescued. Never wear a Type IV PFD.

## Type V

This life jacket is designed for special activities and may be worn instead of a Type I, II or III life jacket if used in accordance with the approval conditions on the label. If a Type V life jacket is part of the minimum on-board life jacket requirements and if it has a label that indicates “required to be worn,” it must be worn at all times, otherwise one additional Type I, II or III life jacket must be on-board to satisfy the minimum life jacket requirements. Some Type V life jackets provide increased protection against hypothermia.

Other special life jackets are available for skiing and other water sports. These life jackets are constructed with materials suitable for high-impact falls. When selecting these life jackets, ensure that they meet USCG approval requirements.

Note: Inflatable USCG-approved life jackets are not to be used by persons under the age of 16.

## Children’s Life Jackets

All life jackets are clearly labeled with the appropriate weight range. Check the label to match the weight range of your child. To check for a good fit, pick the child up by the shoulders of the life jacket. If the life jacket fits, the child’s chin and ears will not slip through.

Children weighing between 30 and 50 pounds may like the freedom of movement that a Type III life jacket provides; however, a Type I or Type II life jacket will usually offer greater protection for most children in this weight range, especially those who cannot swim.

- Use a life jacket with a collar that turns a child’s face up in the water. It must have strong straps and buckles, a handle on the collar and, preferably, be bright yellow or orange in color for high visibility.

- Attach a plastic safety whistle to the life jacket. Teach the child how to use the whistle, and practice using it and signaling for help.

Note: Inflatable USCG-approved life jackets are not to be used by persons under the age of 16.

### **Audible Distress Signaling Devices**

Audible (sound) distress signals are required to be on-board all boats. A boat less than 39.4 feet (12 meters) must always have an efficient sound-producing device on-board (Example: hand or mouth whistle, or a compressed or powered air horn).

A boat at least 39.4 feet (12 meters) but less than 65.6 feet (20 meters) operating in inland waterways must always have a power whistle or powered air horn and a bell on-board.

All devices must be acceptable for use in marine environments, audible for 1/2 nautical mile and maintain a continuous four- to six-second sound duration. The diameter of the bell's mouth must be a minimum of 7.9 inches (20.0 centimeters).

Ensure all passengers understand how to operate all audible distress signaling devices on-board. Keep these devices in a readily accessible area and within immediate reach at all times when boating.

For specific on-board requirements, see *U.S. Coast Guard Minimum On-Board Personal Safety Equipment Required* on page 3-32 and for usage information, see *Audible Distress Signals* on page 7-1.

### **Visual Distress Signaling Devices**

Boats less than 16 feet (4.9 meters) must have USCG-approved Visual Distress Signals (VDS) on-board when operating between sunrise and sunset in coastal waters, including ocean bays, gulfs and sounds, as well as the Great Lakes, seas, bays and river mouths that are 2 or more miles wide and only to the point proceeding inland where the water narrows to less than 2 miles. Visit the U.S. Coast Guard website for additional information on specific VDS requirements for your boat.

Ensure all passengers on-board understand how to operate all VDS. Keep VDS in a readily accessible area and within immediate reach at all times when boating.

## VISUAL DISTRESS SIGNALS

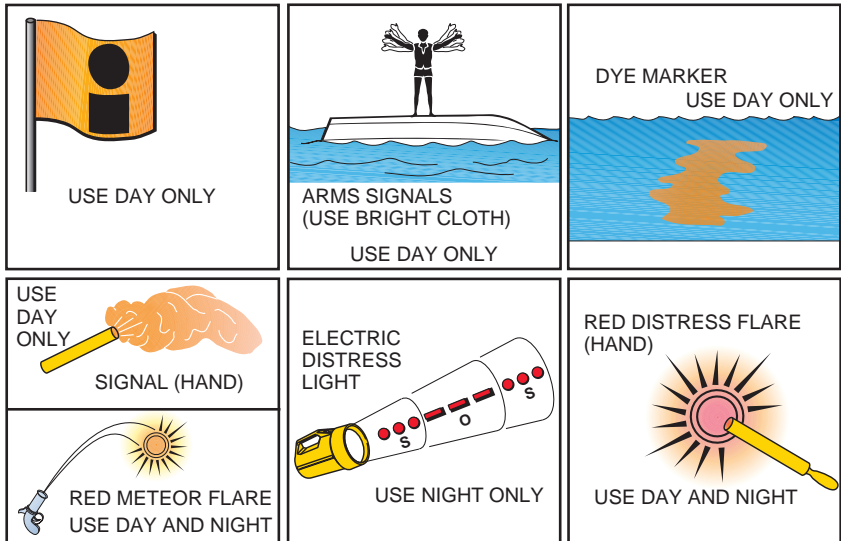

KC-0008C-B

**Figure 3-10**

Regulations prohibit using pyrotechnic VDS or any VDS in non-emergency situations.

VDS must be:

- USCG-approved
- In proper operating condition
- Safely stowed and readily available
- Within the clearly marked expiration date stamp on the device (where applicable)

Types of VDS vary by emergency situation. VDS are classified as either pyrotechnic or non-pyrotechnic.

Note: Some pyrotechnics may be restricted on certain bodies of water. Check with local authorities, or visit the National Association of State Boating Law Administrators (NASBLA) website: <http://www.nasbla.org> or the U.S. Coast Guard website: <http://www.uscg.mil> for additional information.

For specific on-board requirements, see *U.S. Coast Guard Minimum On-Board Personal Safety Equipment Required on page 3-32*.

### Engine Emergency Stop Switch and Lanyard

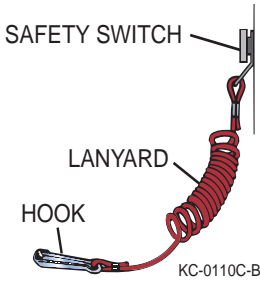

The engine emergency stop switch is an extremely important safety precaution. Use the engine emergency stop switch when operating the boat's engine. This safety device prevents your boat from becoming a runaway if you are accidentally thrown from the seat or away from the helm.

Before turning on the boat's engine, secure the engine emergency stop switch lanyard to the operator. If the operator is thrown from the seat or moves too far from the helm, the lanyard will disconnect from the switch, activating the switch to turn off the engine.

Never remove or modify the engine emergency stop switch and/or lanyard.

Always keep the lanyard free from obstructions that could interfere with its operation.

Always check the switch for proper operation. With the engine running, pull the lanyard. If the engine does not stop, have the switch repaired before continuing to operate your boat. Never operate your boat if the engine emergency stop switch does not work.

### Navigational Lights

Navigational lights are intended to alert other boats to your presence and course.

Regulations require that navigational lights be clearly lit and properly displayed at all times between sunset and sunrise, and always when operating in reduced visibility. The placement, shape and visibility requirements of navigational lights may vary depending on usage. Check with local authorities, or visit the NASBLA or U.S. Coast Guard website for additional information.

For additional information, see *Navigational Lights & Night Operation* on page 7-2.

## RECOMMENDED SAFETY EQUIPMENT

Carry and know how to use the following equipment in addition to the required equipment on-board at all times as an extra safety precaution:

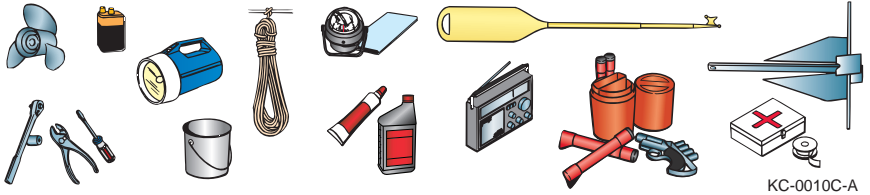

**Figure 3-11**

Anchor and line with minimum 75 feet (23 meters) of line	Fuses
Auxiliary starting battery	GPS Global Positioning Device
Boat hook	Insect repellent
Cellular phone	Local charts and compass
Compass	Mooring lines
Dock fenders	Navigational and interior light bulbs
Duct and electrical tape	Oar/paddles
Electrical wire	Propeller, nut and washer
Emergency food and water	Radio
Emergency Position Indicating Radio Beacon (EPIRB)	Spark plugs
Engine lubricant	Sunglasses and sun block
Extra drain plug	Thermal clothing
Extra keys	Tool kit including propeller replacement tools
First aid kit and manual	Tow line
Flashlight	VHF-FM/AM with weather band radio
Flashlight and radio batteries	Waterproof flashlight
Foul weather gear/clothing	

### SEATING LOCATIONS

Your tow boat is a high-performance craft capable of rapid acceleration, high speeds and tight turns. The operator is responsible for the safety of passengers and must instruct on the proper seating locations and the use of hand-holds. The number of persons onboard must be determined by the combined weight of passengers, gear and ballast and must not exceed the maximum weight capacity listed on the Capacity Plate. With full ballast, full fuel and gear for 5 adult skiers, the maximum number of persons based on weight may be 6, even though the Capacity Plate lists 11.

Passengers must always be seated in the proper locations, on the horizontal seat surface, and use the provided hand-holds while underway. The operator must pay special attention when children are riding in the bow seats as water conditions can change rapidly causing an unsafe condition. Small children should never be allowed to ride in the bow seats without adult supervision. Refer to the designated people placement for your model.

### Designated Seating Positions

#### Centurion Ri257



Figure 3-12



**Centurion Ri237**

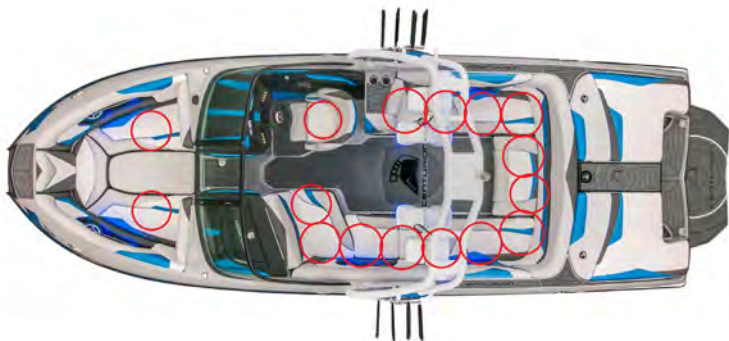

*Figure 3-13*

**Centurion Ri217**

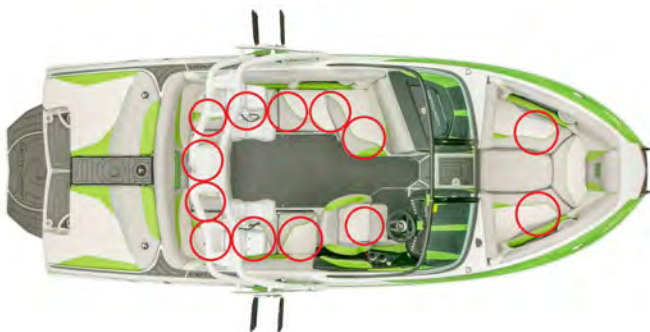

*Figure 3-14*

**This Page Intentionally Left Blank**

# CENTURION BOATS

## Section 4

# BOATING REGULATIONS & YOUR RESPONSIBILITIES

The U.S. Coast Guard (USCG) is the federal authority on U.S. coastal and inland waterways, but state and local regulations may exist that exceed USCG regulations. The purpose of all of these regulations is to assist the boating public and maintain navigational order on waterways.

Many state equipment requirements go beyond USCG requirements. Contact your state and local boating authorities for further information. Equipment requirements for coastal and inland waters differ. Check with local authorities or the USCG for further information about coastal water requirements.

Boating regulations are enforced by USCG, state and local authorities. You are subject to marine navigation regulations for both federal and state waterways. You must comply if enforcement officers signal you to stop your boat or if they ask to board your boat.

Many USCG, state and local resources are available to you. For additional and current information on regulations, safety and navigation, contact your local USCG unit or local marine authority.

See *References and Contact Information on page 1-6* for a list of resources.

## BOAT OWNER / OPERATOR RESPONSIBILITIES

As a boat owner/operator, understand and be aware of USCG federal regulations as well as state and local regulations where you operate your boat. Boating regulations include, but are not limited to, boat regulations, boat equipment regulations and navigational regulations.

You must have on-board at all times all mandatory safety and boat equipment as regulated by the governing authorities. All equipment must be maintained in proper working order.

### **SAFETY**

As a boat owner/operator, you are legally responsible for your safety, the safety of your passengers and the safety of other boaters. In addition, you are responsible for the operation and navigation of your boat under all operating conditions. Your boat must be in compliance with USCG safety equipment regulations.

### **REGISTRATION**

The USCG requires that all power boats operated on the navigable waters of the United States be currently registered in the state in which they are principally used. Many states require current registration in that state whenever boating on waters within their state boundary. Always contact your state boating authorities (and authorities in neighboring states) for registration information on boats and trailers.

Registration numbers must be current and clearly displayed on the boat according to the defined regulations. Registration certificates must be current and on-board at all times.

State and local authorities may require additional registration for boating on certain waterways. Check with state and local authorities for additional registration information.

For more information visit:

- U.S. Coast Guard Office of Boating Safety: <http://www.uscgboating.org>
- National Association of State Boating Law: <http://www.nasbla.org>

### **INSURANCE**

As a boat owner, you are legally responsible for any damage or injury caused when you or someone else is operating your boat when an accident or collision occurs. Individual states have laws detailing minimum insurance needs. Contact your insurance agent to verify the type of insurance you need BEFORE operating your new boat.

### **REPORTING ACCIDENTS**

The USCG requires the owner/operator of a boat involved in an accident to report the incident to the proper marine law enforcement agency for the state in which the accident occurred. If a person dies or disappears as a result of a recreational boating accident, the boat owner/operator must immediately notify the nearest state boating authority. If a person dies or injuries requiring more than first aid are involved, the owner/operator must file a formal report within 48 hours of the accident. An owner/operator has 10 days to file a formal report for accidents exceeding \$500 in property damage or complete loss of boat.

## BOATING UNDER THE INFLUENCE



KC-0011C-B

Federal and state laws prohibit the operation of a boat while under the influence of alcohol or drugs, and authorities actively enforce these regulations. If the operator's blood alcohol content is 0.08% or above, violators are subject to civil and criminal penalties and imprisonment. Operating a boat under the influence can also result in a loss of motor vehicle driving privileges.

Alcohol and drugs slow your reaction time and affect your judgment. This type of impaired operation may result in death or severe personal injury.

As the owner/operator, you are responsible for the alcohol and drug use, as well as on-board behavior, of your passengers.

Regulations and penalties for operators and passengers may vary from state to state. Contact your local and state boating authorities for specific information.

## OPERATOR'S LICENSE AND EDUCATION

This manual does not provide complete training on all aspects of boating safety, operation or regulations. Boating authorities highly recommend that all boat operators and passengers seek additional training in boating safety and seamanship from a USCG-approved course.

Some states require youths 16 years of age and younger to complete a boating safety course before operating any watercraft. Many others require operators under the age of 18 to be licensed in small boat operation.

Check with your state and local authorities for requirements of operator's license, certificate or training before you or anyone operates your boat.

See *References and Contact Information on page 1-6* for a list of some of the agencies and organizations that offer water/boating safety courses, first aid/CPR, or other recommended training and/or information.

## OPERATION BY MINORS

Minors must always be supervised by an adult whenever operating a boat. Many states have laws regarding the minimum age and licensing requirements of minors. Regulations may vary from state to state. Contact your local and state boating authorities for specific information.

### EMERGENCY ASSISTANCE

If you see a distress signal or suspect a boat is in trouble, you must assume it is a real emergency and render assistance immediately. By law, the operator in charge of the boat is obligated to provide assistance to any individual in danger if such assistance can be provided safely. Failure to render assistance can result in a fine and/or imprisonment. The 1971 Boating Safety Act grants protection to a “Good Samaritan” boater providing good faith assistance, and absolves a boater from any civil liability arising from such assistance.

### PROTECTING THE ENVIRONMENT

As a boat owner/operator, you are responsible for protecting wildlife and the natural environment by keeping waterways clean. There is currently a tremendous drain on our natural resources. Excessive fishing and hunting, as well as pollution, have strained the fish and game population. Do your part by keeping only what you will eat; practice catch-and-release and obey bag limits.

### FOREIGN SPECIES TRANSPORTATION

If you trailer your boat from lake to lake, you may unknowingly introduce a foreign aquatic species from one lake to the next. Thoroughly clean your boat below the waterline, remove all weeds and algae, and drain the bilge and livewells before launching your boat in a new body of water.

### NOISE

As a boat owner/operator, you are responsible for the noise your boat creates. Many state and local boating authorities enforce noise limits that may restrict engine noise, radio volume or even loud talking. Regulations may vary from state to state. Contact your local and state boating authorities for specific information.

### SPEED

As a boat owner/operator, you are responsible for maintaining your boat under control at a safe speed. Many state and local boating authorities enforce speed limits. Regulations may vary from state to state. Contact your local and state boating authorities for specific information.

### WAKE

As a boat owner/operator, you are responsible for the wake your boat creates. Regulations may vary from state to state. Contact your local and state boating authorities for specific information, as you may be responsible for any damage or injury your wake causes. Always be alert for NO WAKE zones and be courteous of others while boating. Excessive and unexpected wakes can cause dangerous and even life-threatening situations.

## POLLUTION REGULATIONS

The discharge of any type of debris or waste into the water, including, but not limited to, food, trash, garbage, oil, fuel, liquids and human waste, is highly restricted and sometimes considered unlawful. Authorities highly recommend that you NEVER discharge anything into the water.

Become familiar with the following pollution regulations. Pollution is a serious matter, and law enforcement authorities highly enforce these regulations. As a boat owner/operator, you are responsible for your actions affecting the environment; therefore, you must fully understand and be aware of these regulations. Contact the USCG, state and local authorities for additional information.

### MARPOL Treaty

The USCG enforces the International Convention for the Prevention of Pollution from ships, commonly referred to as the MARPOL Treaty (MARine POLLution). This treaty prohibits the overboard dumping of all ship-generated plastics, chemicals, garbage and oil. Contact the USCG for further information.

### Refuse Act of 1899

The Refuse Act of 1899 prohibits throwing, discharging or depositing refuse matter of any kind (including food, trash, garbage, oil and other liquid pollutants) into U.S. waterways.

### Federal Water Pollution Control Act

The Federal Water Pollution Control Act prohibits the discharge of oil or hazardous, potentially harmful substances into U.S. navigable waters. Boats at least 26 feet (7.9 meters) in length must display a placard at least 5 x 8 inches (127 x 203 mm), made of durable material, fixed in a conspicuous place in the machinery spaces, or at the bilge pump control station, stating the following:

Discharge of Oil Prohibited
The Federal Water Pollution Control Act prohibits the discharge of oil or oily waste upon or into any navigable waters of the U.S. The prohibition includes any discharge which causes a film or discoloration of the surface of the water or causes a sludge or emulsion beneath the surface of the water. Violators are subject to substantial civil and/or criminal sanctions including fines and imprisonment.

### Federal Oil Pollution Act of 1990

The Federal Oil Pollution Act of 1990 was passed by Congress to prevent further oil spills from occurring in the U.S. As a boat owner, be familiar with your liability under this act, as you may be liable for the cost of actions in the prevention and/or removal of, or damage from, oil spills created by you.

### Exhaust Emissions

As a boat owner, you are responsible for the exhaust emissions from your boat. Increased exhaust (hydrocarbon) emissions, which are regulated by the EPA, pollute the water and air. Contact your dealer and the engine manufacturer for more information. Additional restrictions may apply and vary from state to state. Contact your local and state boating authorities for specific information.

### Proposition 65

A wide variety of components used on this vessel contain or emit chemicals known to the state of California to cause cancer, birth defects and other reproductive harm.

#### Examples include:

- Engine and generator exhaust
- Engine and generator fuel and other liquids, such as coolants and oil, especially used motor oil
- Cooking fuels
- Cleaners, paints and substances used for vessel repair
- Waste materials that result from wear of vessel components
- Lead from battery terminals and from other sources, such as ballast or fishing sinkers

#### To avoid harm:

- Keep away from engine, generator and cooking fuel exhaust fumes.
- Wash areas thoroughly with soap and water after handling the substances above.



# Boating Regulations & Your Responsibilities

**⚠ WARNING**

A wide variety of components used on this vessel contain or emit chemicals known to the State of California to cause cancer and birth defects and other reproductive harm.

**EXAMPLES INCLUDE:**

- Engine and generator exhaust.
- Engine and generator fuel, and other liquids such as coolants and oil, especially used motor oil.
- Cooking fuels.
- Cleaners, paints and substances used for vessel repair.
- Waste materials that result from wear of vessel components.
- Lead from battery terminals and from other sources such as ballast or fishing sinkers.

**TO AVOID HARM:**

- Keep away from engine, generator and cooking fuel exhaust fumes.
- Wash area thoroughly with soap and water after handling the substances above.

California Health & Safety Code 25249.5-.13

KC-0206C-B

**Figure 4-1**

## State of California Requirements

Your boat is equipped with a PCM engine that meets the strict 4-star requirements outlined by the California Air Resources Board (CARB). The boat has one of the following labels affixed to it as required by CARB on the port side bow. The label has 4 stars and **MUST** be affixed to your boat if it is operated in the state of California and/or bordering waters.

For more information visit: <http://www.arb.ca.gov>.



KC-0211-C

**Figure 4-2**

## Cleaning Agents

As a boat owner, you are responsible for the environmental regulations that may govern the use of cleaning agents. Use household cleaners sparingly and never discharge them into waterways. Do not mix cleaners and be sure to use plenty of ventilation in enclosed areas. Avoid using chlorine, solvents and products that

contain phosphates, as well as non-biodegradable or petroleum-based products. Regulations may vary from state to state. Contact your local and state boating authorities for specific information.

### **Paints**

As a boat owner, you are responsible for the environmental regulations that may govern the use of antifouling paint. If your boat is kept in water where marine growth, discoloration or “blistering” of the hull below the waterline is a problem, the use of antifouling paint may reduce the growth rate. Regulations may vary from state to state. Contact your local and state boating authorities for specific information.

# CENTURION BOATS

## Section 5

# EMERGENCIES

Before operating your boat, see *Safety on page 3-1*.

Be prepared to deal with emergencies before they happen. Try to formulate a plan for each type of emergency in advance so you can make decisions quickly and without hesitation. Precious moments lost can mean the difference between losing and saving a life.

## FIRST AID / MEDICAL EMERGENCIES

Every second counts toward preventing injury or death in case of a medical emergency. Boaters must have proper training and take necessary preventive measures to properly assist in times of need. Carrying an adequate and current first aid kit is critical in the immediate response and care of someone in need of medical attention. Always have dry blankets readily accessible to help prevent hypothermia. For additional information on medical, first aid and safety training such as CPR, contact your state and local authorities, or visit the Red Cross website:

<http://www.redcross.org>

## EMERGENCY PREPARATION CHECKLIST

In addition to a safety equipment list, have an emergency checklist on-board to assist in times of emergency. Use the following topics as a guideline to develop a list of emergency procedures and instructions for the use of visual and audible distress signaling devices, radios, first aid kits and all related information that could assist you or others in the event of an emergency.

## CARBON MONOXIDE POISONING

**DANGER! Carbon Monoxide (CO) is a colorless and odorless gas produced by all engines, fuel-burning appliances, and any material that contains carbon and is burned.**

Do not confuse carbon monoxide poisoning with seasickness, intoxication or heat stress. If someone complains of irritated eyes, headache, nausea, weakness, dizziness or drowsiness, or you suspect carbon monoxide poisoning, immediately move the person to fresh air, investigate the cause and take corrective action. Seek medical attention if necessary.

For additional information, see *Carbon Monoxide on page 3-31*.

# FIRE AND EXPLOSION

For additional information on extinguishing fires and specific fire extinguisher requirements, see *Fire Extinguisher* on page 3-33.

**DANGER! Gasoline is extremely flammable and highly explosive under certain conditions.**

- Do not smoke or allow open flames or sparks nearby when refueling.
- Do not store fuel in any containers or compartments which are not designated for fuel storage.
- Static electricity can be generated while fueling and can cause a fire or explosion. To prevent electrostatic spark when refueling, make sure the nozzle is in contact with the fill pipe at all times.
- Avoid damaging fuel lines and connectors and make sure fuel does not contact hot engine parts.
- USCG-approved fire extinguishers are required on all Class I, II and III boats.

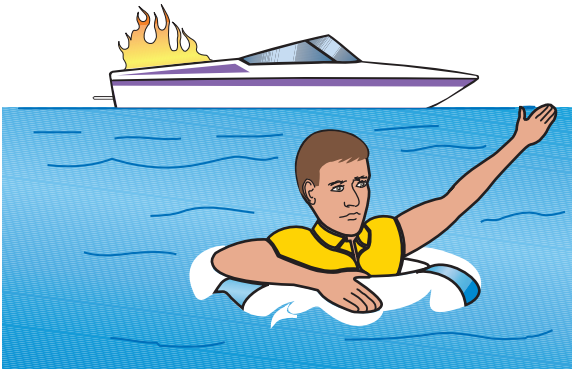

KC-0252C-A

**Figure 5-1**

A fire or explosion may occur when you least expect it. Your decision to abandon the boat or stay to fight the fire is difficult and depends on many factors. Formulate a fire plan in advance to make that decision quickly and without hesitation. Keep in mind the following guidelines:

- Many fires are the result of gasoline and oil accumulating in the bilge, careless fueling practices and electrical problems. In the event of a fire, try to stop the boat and turn off the engine as quickly and safely as possible. Immediately use a fire extinguisher at the base of the flames in a sweeping motion to reduce or extinguish the fire. Ensure that all passengers are safe from immediate danger and are wearing life jackets. If the fire is located in the engine compartment (if equipped), make sure the bilge blower (if equipped) is off and do not open the engine cover.
- Once you have extinguished the fire, check for other immediate fire threats and personal injuries and call for assistance immediately.
- If you are unable to easily extinguish the fire, or if the fire is uncontrollable, attempt to get yourself and all passengers off the boat and into the water. If possible, ensure that all passengers are wearing life jackets or have access to one by the time they are in the water. Before leaving the boat, if possible, verify that there is no immediate danger of fuel sitting or burning on the water's surface where you and your passengers will be floating. Immediately swim to a safe position upwind from the boat and use distress signals to get assistance.

## USING DISTRESS SIGNAL DEVICES AND CALLING FOR HELP



Ensure all passengers understand how to operate all on-board visual and audible distress signaling devices and communication equipment. Keep all distress signaling devices and communication equipment in a readily accessible area and within immediate reach at all times.

An emergency can occur when you least expect it. Be sure you and your passengers know how to use all types of distress signaling devices. Seconds count during emergencies. Knowing the proper way to use the distress signaling devices on-board your vessel can help save lives.

The word “MAYDAY” is the international signal of distress. Use “MAYDAY” only in emergency situations.

In emergency situations and when lives are in danger, you may need to use VHF-type two-way radios, cell phones and Emergency Position Indication Radio Beacons (EPIRBs). Knowing the proper use and operation of these communication devices is critical. Make sure you know what channels to use and numbers to call. Know how to send an efficient and informative message about your emergency to ensure that proper help and assistance can be provided.

## Section 5

The VHF-type radio channel commonly used for communicating distress, safety and urgent calls is Channel 16.

To contact the USCG for an emergency while on the water, always use your on-board VHF-FM radio (Channel 16). Use cell phones only as a secondary means of communication. The number to call within the U.S. is 911.

For additional information on the safe and proper use of distress signaling devices and the safe and proper use of emergency communication equipment, contact your state and local authorities. Additional information can be found on the USCG website:

<http://www.uscgboating.org>.

## CAPSIZING AND FLOODING

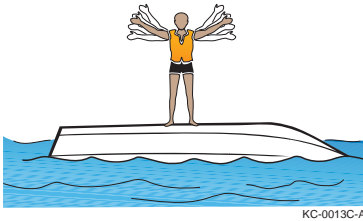

A boat may capsize or flood when you least expect it. Formulate a plan in advance in case of capsizing or flooding. Review the following guidelines:

- If your boat capsizes, locate all passengers and guide them to a safe flotation device or the forward hull if your boat is floating upside down.
- If possible, provide life jackets to all persons in the water and assess them for alertness and injuries.
- **STAY WITH THE BOAT!** Climb up on the hull and try to get assistance.
- Do not try to swim to shore, as it can be farther than it appears.

If your boat starts to flood, slow the boat to a safe speed and stop as quickly as possible. Activate the bilge pump(s) immediately. Try to locate the cause of the flooding. If the cause is not readily apparent or not easily corrected, head for shore or shallow water as quickly as possible and call for help.

## MAN OVERBOARD

If someone falls into the water unexpectedly, use the following guidelines. Every second counts toward preventing injury or death.

At the first sign that a person has fallen overboard, loudly yell “Man overboard!” and state the position of the person in relation to the boat (Example: “Man overboard - port!”).

Set the engine throttles at idle and place the gear controls in the NEUTRAL position immediately.

Throw a Type IV PFD to the victim immediately if the PFD will be within reach of the victim. If the victim is too far away to throw a PFD to, navigate back and throw the PFD from a safe distance. If a Type IV PFD is not readily available, any life jacket or floating device will suffice.

Someone in your boat must keep the victim in sight at all times. It is the captain's responsibility to assign one person to watch the victim.

Carefully navigate back to the victim, staying at a safe distance and position to safely retrieve the victim.

Avoid going into the water to assist the victim unless there is absolutely no way to retrieve the victim safely from your boat and there is no chance of endangering others.

## RUNNING AGROUND

When a boat runs aground, the stop is usually abrupt. Because passengers are not secured to a seat, abruptly stopping a boat while in motion can cause serious personal injury or even death. First, turn off the engine(s) immediately, locate all passengers and attend to any injuries, calling for emergency assistance as needed. Then, assess the damage to your boat and determine if there are any other immediate threats such as water leaking into your boat, or fuel or flammable materials leaking into the water or inside your boat. Immediately call for assistance if threats exist that could endanger the safety of passengers.

If there are no immediate safety threats to passengers and your boat is not damaged, attempt to propel it away from the obstacle. If the engine or drive system has been damaged and the engine restarts, be aware of excessive vibrations or uncommon noises, which usually indicate damage to the drive system. If this is the case, it is not safe to proceed. Call for emergency or professional towing assistance immediately.

**WARNING! Use extreme caution when using tow lines and when connecting tow lines to cleats. Death or serious injury could occur when lines and/or cleats fail while they are under extreme tension.**

If the engine restarts and your boat can be navigated back safely to port, proceed slowly back to port and be ready to call for emergency assistance if needed. Even if your boat and engine appear to be in good operating condition after running aground, have the boat inspected by a qualified marine technician BEFORE returning it to service. Damage may have occurred that is not obvious to you as an operator.

### DANGEROUS WEATHER

Take special precautions when encountering or operating in dangerous or hazardous weather conditions.

For additional information, see *Severe Weather* on page 6-1.

### ENGINE OR BOAT SYSTEM FAILURE

In the event of an engine or boat system failure and when not in immediate danger, try to troubleshoot or identify the problem before calling for assistance.

For additional information, see *Troubleshooting* on page 13-1.

### ACCIDENTS, COLLISIONS AND GIVING ASSISTANCE

A collision or accident may occur when you least expect it. Formulate a course of action in advance in case of a collision or accident. Keep in mind the following guidelines:

- If an accident or collision occurs involving your boat, locate all passengers first and verify and secure their safety. Check for injuries and provide all passengers with a flotation device.
- Once you have determined that your passengers are not in danger, provide assistance to passengers on the other boat.
- Immediately call for help and then assess the damage to the boats. Render necessary assistance to prevent further damage or personal injury.

The USCG requires the owner/operator of a boat involved in an accident to report the incident immediately to the proper marine law enforcement agency for the state in which the accident occurred.

If you witness or are aware of an accident or collision while boating, you must report it immediately and provide assistance.

If you see a distress signal or suspect a boat is in trouble, you must assume it is a real emergency and render assistance immediately. Once you have determined that a real emergency exists, call for help immediately and then provide assistance to all passengers to ensure their safety.

### TOWING ON THE WATER

If you encounter a situation where you are asked to tow or be towed for any reason, assess the situation and try to contact a professional towing service or other emergency assistance first. When encountering a boat in distress, always offer emergency or safety assistance and/or call for assistance for the distressed parties if necessary. Towing or being towed presents an increased risk of personal injury and boat damage.



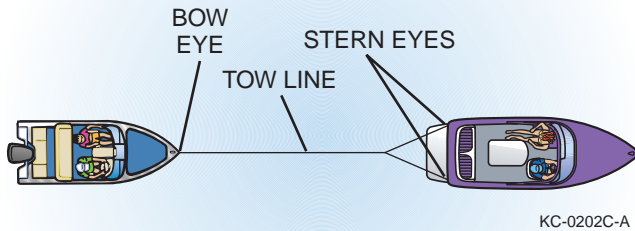

**Figure 5-2**

**WARNING! Use extreme caution when using tow lines and when connecting tow lines to cleats. Death or serious injury could occur if lines and/or cleats fail while they are under extreme tension.**

Follow these guidelines when towing or being towed:

- Use extreme caution when throwing weighted lines to a boat in distress. When in rough seas, use a light throwing line with a weight secured on the throwing end and a heavier towing line secured to the other end.
- Never attempt to tow a boat larger or heavier than your own.
- Never attempt to tow a grounded, damaged or capsized boat.
- Use a tow line that is rated at least four times the gross weight of the boat being towed.
- Make sure tow lines are in good condition and are free of damage, cuts or abrasions.
- Attach a tow line to the bow eye on the disabled boat. Never attach a tow line to any point on the disabled boat other than the bow eye.
- Attach the tow line to the stern eyes of the tow boat. Wrap the tow line with chafing gear where it rubs against the boat or any corners.
- Leave at least two boat lengths between the boats for adequate movement.
- Never allow anyone to be in line with the tow line. If the line breaks or pulls free, dangerous recoil could occur, resulting in severe injury or death to anyone in its path.
- Adjust the tow line to match wave action. Keep the boats on the crest or in the trough of the waves at the same time. In protected, calm waters, shorten the line for better handling.
- Tow at moderate speed, allowing for adverse wind and wave conditions.
- Have the operator of the towed boat steer with you if possible.
- Have a person on the tow boat watch the disabled vehicle and, if necessary, be available to signal the operator of the disabled boat.

Check with local and state authorities prior to towing for additional regulations and restrictions on towing other boats or equipment.

**This Page Intentionally Left Blank**

# CENTURION BOATS

## Section 6

# OPERATING IN HAZARDOUS CONDITIONS

Before operating your boat, see *Safety* on page 3-1.

## SEVERE WEATHER

Getting caught in severe weather can be dangerous and even fatal. Check with local weather stations, the USCG or weather-service broadcasts (162.55 or 162.40 MHz) for the latest conditions. Check the weather not only before you go out on the water, but also periodically while you are on the water. Consult the following websites for weather information:

- [www.weather.com](http://www.weather.com)
- [www.nws.noaa.gov](http://www.nws.noaa.gov)
- [www.navcen.uscg.gov](http://www.navcen.uscg.gov)

## Storm Conditions

Take the following precautions if you operate your boat in storm conditions:

- Have all occupants wear life jackets.
- Turn on navigation lights.
- Locate and have inclement weather gear and safety equipment ready.
- Mark or identify your position.
- Close all ports, stow all gear and secure any loose equipment on deck.
- Reduce speed and head for port or a safe, easily reachable place.
- Keep a lookout for debris and obstructions in the water.
- When possible, head into the waves at a 45-degree angle. Allowing high waves to strike the side of your boat may cause it to capsize or swamp.
- If you lose power, keep your boat headed into the waves by rigging a sea anchor off the bow.

### Fog Conditions

Avoid operating your boat in foggy weather, if possible. If you encounter fog conditions, return to port immediately. Also, take the following precautions:

- Reduce speed to a safe speed or idle.
- Take bearings and log your course and speed before the fog sets in. Use of a GPS is recommended.
- Have all occupants wear life jackets.
- Assign lookouts to the bow and stern to keep watch and listen.
- While navigating in fog, you must sound a five-second blast from your horn or whistle once every two minutes to alert other boaters of your position.
- If you determine that it is unsafe to continue navigating your boat, quickly find the best position to anchor. You must sound a five-second blast from your horn or whistle once every minute while anchored to alert other boaters of your position.

### Reduced Visibility

Natural environments and inclement weather can cause reduced visibility. Storm condition hazards can be compounded by reduced visibility while on the water. Always use common sense and take safety precautions if you are operating your boat in reduced visibility conditions.

### Cold Weather and Cold or Frozen Water Conditions

Avoid operating your boat in cold water or weather conditions, and never operate in frozen or icy waters. Operating in these conditions significantly increases the risk of serious injury or death. Boating in these conditions can lead to cold-water immersion, shock or hypothermia. Weather conditions may hinder emergency rescue or assistance, and cold weather poses potential problems for on-board equipment, as well as the engine. See the *Engine Operator's Manual* and the equipment manufacturer's instructions for operating in cold weather.

## WATER HAZARDS

Every waterway poses hazards that you must be aware of and avoid. These hazards include shallow water, tree stumps and sand bars. Ask local authorities and other boaters for information and consult a marine chart when boating on unfamiliar waters. As a boat operator, try to avoid all hazards, known and unknown.

## Dams and Spillways

The waterways around dams and spillways are extremely hazardous. Dams and spillways are subject to rapid water flow changes, and may have floating and sunken debris in the nearby water. These areas are often marked as restricted, and it is best to always stay clear of them.

## Aquatic Vegetation/Weeds

Operating in weeded areas can be extremely hazardous. Aquatic vegetation can be a threat to your boat's drive system. Vegetation and weeds can wrap around the propeller, causing loss of propulsion and steering control. They may also restrict the engine water cooling intake, causing the engine to overheat. Avoid operating in or near vegetation. If you encounter any restriction because of vegetation, stop the engine. See the *Engine Operator's Manual* for recommendations on the removal of vegetation from the propeller and water cooling intake ports. Be extremely careful and never get into the water when clearing the propeller. Stay out of the water in highly congested vegetative areas, which can severely restrict your mobility and create a life-threatening situation.

*NOTICE: Vegetation can sometimes be removed by shifting to NEUTRAL, pausing a moment, then shifting to REVERSE to unwind the vegetation from the propeller.*

## Shallow Water Operation

Operating in shallow water presents a number of hazards. Sandbars in narrow inlets are constantly shifting, making it difficult to mark them with buoys. Sandbars are sometimes indicated by waves as they form into breakers when passing over the sandbar. In coastal areas, tides can affect water level as much as 30 feet (9 meters). Check with local marinas or Coast Guard stations for tide tables and current charts.

## RESTRICTED AREAS

Some waterways and areas are restricted. Always check with local, state and federal authorities to identify restricted areas. Because of the threat of terrorism, the USCG has implemented and will continue to enforce strict limits on watercraft near U.S. Navy and Coast Guard ships and other potential targets. For more information, contact the USCG or local authorities.

## MARKERS, WARNINGS AND ADVISORIES



KC-0015C-B

Find out from local authorities if hazards exist in areas where you intend to navigate, and know how these hazards are marked. You must also recognize flag designs that indicate hazards or activities that are present and keep well clear of those areas. Always watch for swimmers and stay clear of all swimming areas, marked or unmarked.

Become familiar with navigation markers, which identify navigable routes and indicate water hazards. Always stay within marked boundaries and steer clear of hazards.

Distress flags and indicators are markers of potential emergencies and hazards. Become familiar with these flags and indicators. Additionally, understand your responsibilities when operating at these times and in these areas.

DIVERS FLAG



USED BY RECREATIONAL DIVERS - INDICATES DIVER'S POSITION

ALPHA FLAG

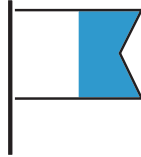

WORLDWIDE VESSELS ENGAGED IN DIVING OPERATIONS - DOES NOT INDICATE DIVER'S POSITION

DISTRESS FLAG









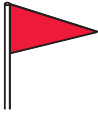

INDICATES FELLOW BOATER IS IN NEED OF ASSISTANCE

KC-0017C-A

**Figure 6-1**

Storm warning advisory flags and indicators alert boaters to impending weather conditions. Become familiar with these flags and indicators and understand the potential hazards associated with operating in these conditions.

# Operating in Hazardous Conditions

DAYTIME WARNING	DESCRIPTION	NIGHTTIME WARNING	DAYTIME WARNING	DESCRIPTION	NIGHTTIME WARNING
	<b>Small Craft Advisory</b> - Winds greater than 18 knots, sustained for two hours or more, or hazardous wave conditions. Following a storm, hazardous wave conditions can persist long after the high winds have subsided.			<b>Storm Warning</b> - Sustained winds of 48 knots or greater.	
	<b>Gale Warning</b> - Sustained winds (2 or more hours) of 34-47 knots.			<b>Hurricane Warning</b> - Forecast winds of 64 knots and above. Displayed only in connection with a hurricane.	

KC-0018C-B

**Figure 6-2**

**This Page Intentionally Left Blank**



# CENTURION BOATS

## Section 7

# NAVIGATION RULES AND AIDS

Before operating your boat, see *Safety* on page 3-1.

The following information outlines basic navigational rules. Boating regulations are enforced by USCG, state and local authorities. You are subject to marine navigation regulations for both federal and state waterways. For more information, contact the USCG, state and local marine authorities. The navigational rules for U.S. waterways can be found in the “Navigational Rules” publication. This publication can be found at most marine supply stores, or you may contact the USCG or visit:

[www.navcen.uscg.gov/mwv/NavRules](http://www.navcen.uscg.gov/mwv/NavRules) to view or download the publication.

Any boat 39 feet (12 meters) or longer must have a copy of the “Navigational Rules” publication on-board at all times. Failure to have this document on-board can result in penalties and/or fines.

## AUDIBLE DISTRESS SIGNALS

It is not necessary to sound a signal every time a boat is nearby. It is typical for boat operators to signal their intention, using a whistle, horn or bell, to avoid potentially confusing or hazardous situations. Privileged boat operators customarily signal first, then the yielding boat operators return the same signal to acknowledge they understand and will comply. Use the danger signal (five or more short, rapid blasts) if intent is not clear.

Use the following signal blasts early enough so other boaters notice and understand them:

Audible Distress Signal	Definition
One long blast	Warning signal (coming out of slip or passing astern)
One short blast	Pass on port side
Two short blasts	Pass on starboard side
Three short blasts	Engine(s) in reverse
Five or more short blasts	Danger signal

### RIGHT-OF-WAY

Boats with less maneuverability have right-of-way over more agile boats. You must stay clear of a boat with right-of-way. Examples of boats with right-of-way are:

- Boats aground or not under command
- Boats with restricted maneuverability
- Boats engaged in fishing
- Non-motor boats (having no power propulsion), i.e., rowboats, paddle boats, canoes and sailboats

Small pleasure craft must yield right-of-way to large commercial boats in narrow channels. A boat with right-of-way is sometimes referred to as the privileged boat.

### The General Prudential Rule

The general prudential rule regarding right-of-way is if a collision appears unavoidable, neither boat has right-of-way. Both boats must act to avoid collision.

### NAVIGATIONAL LIGHTS & NIGHT OPERATION

Navigational lights alert other boats to your presence and course, especially when operating at night or in restricted visibility conditions.

Regulations require that navigational lights be clearly lit and properly displayed at all times between sunset and sunrise, and always when operating in reduced visibility. Where applicable, lights must appear on the sides, stern, masthead and all-around positions.

All navigational rules apply at night, but speed is restricted on many waterways. Night boaters must operate at a slow, safe speed and stay clear of all boats, regardless of which boat has right-of-way.

Protect your night vision by avoiding bright lights. If possible, have a passenger help keep watch for other boats, water hazards and aids to navigation.

The size, speed and direction of other vessels are determined at night by white, green and red running lights.

- A green light indicates the starboard side of the boat. Generally, if you see a green light on another boat, you have the right-of-way. Hold your course.
- A red light indicates the port side of the boat. Generally, if you see a red light on another boat, they have right-of-way and you must yield your course.

## SPEED

As the operator, you are responsible for maintaining your boat under control at a safe speed. Many state and local boating authorities enforce speed limits. Regulations may vary from state to state. Contact your local and state boating authorities for specific information.

## WAKE

You, as the operator, are responsible for the wake your boat creates. Always be alert for NO WAKE zones and be courteous of others while boating. Excessive and unexpected wakes can cause dangerous and even life-threatening situations. Regulations may vary from state to state. Contact your local and state boating authorities for specific information, as you may be responsible for any damage or injury your wake causes.

## OVERTAKING / PASSING

The boat overtaking or passing must yield right-of-way to the boat being passed. The overtaking boat must make any adjustments necessary to keep out of the way of the boat being passed. The boat being passed has the right-of-way and must hold its course and speed.

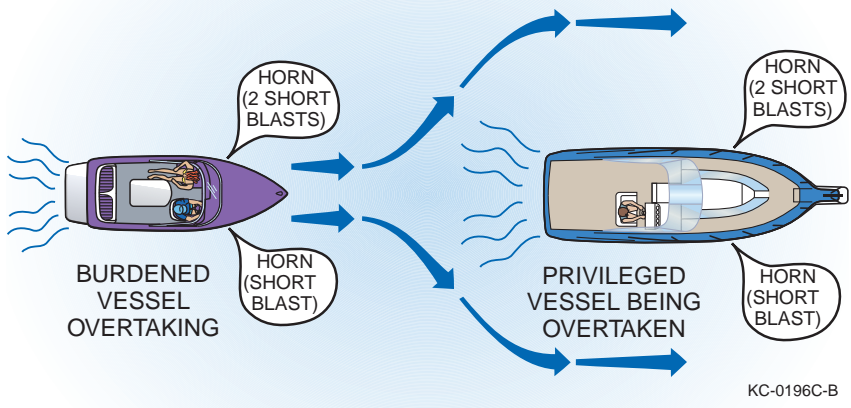

**Figure 7-1**

## MEETING HEAD-ON

When two boats meet head-on, neither boat has the right-of-way. Both boats should decrease speed, turn to the right and pass port to port. If, however, both boats are on the left side of a channel, each vessel should sound two short horn blasts and pass starboard to starboard.

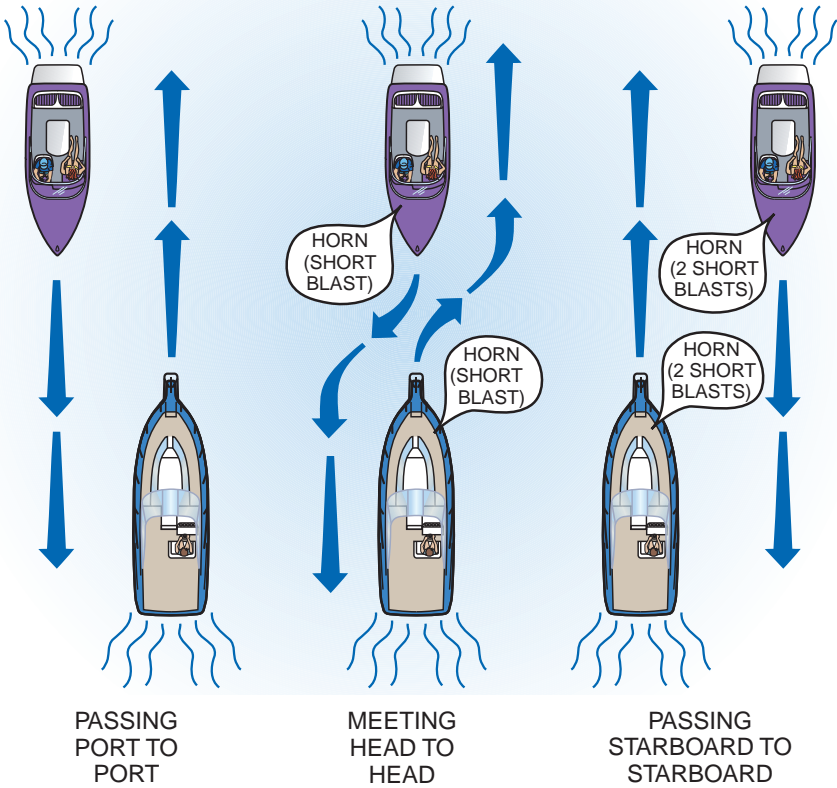

KC-0195C-A

Figure 7-2

## CROSSING

In crossing situations, the boat to the right from the 12 o'clock to the 4 o'clock position has the right-of-way and must hold course and speed. The boat without right-of-way must yield and pass to the stern of the privileged boat. Boats going up and down a river have the right-of-way over boats crossing the river.

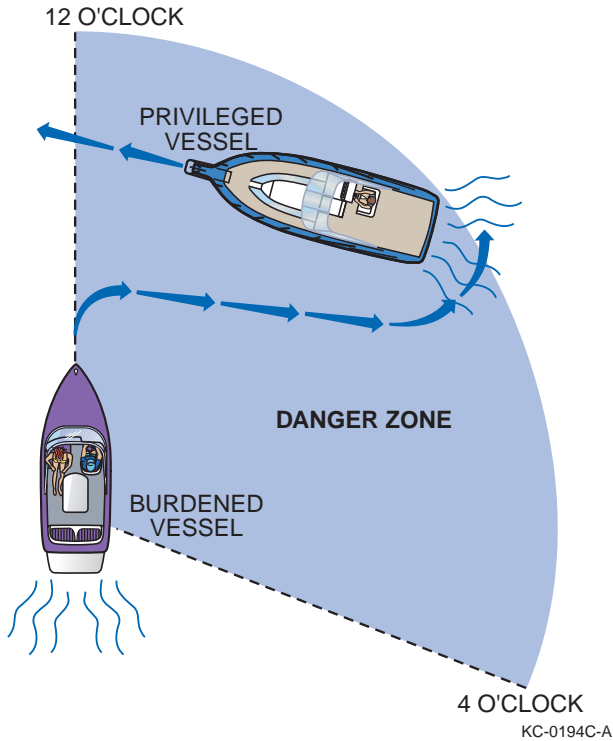

**Figure 7-3**

## AIDS TO NAVIGATION

Learn to recognize the different buoys and day markers; they are the signposts of the waterways. The United States Aids to Navigation System (USATONS) is the primary marking system used on inland water, coastal waters and rivers. This system is maintained by the USCG.

Navigational aids are designed and placed accordingly to help you navigate safely on the water. Learn to recognize the different buoys and day markers.

The following information is based on the USATONS. For further information, contact the USCG and state and local marine authorities. Also visit [www.uscg.mil](http://www.uscg.mil) for buoyage system information.

The USATONS uses buoys, beacons and minor lights as markers.

NEVER tie or anchor to a navigational aid. This action is unlawful and dangerous to you, your boat and other boaters.

NEVER move or damage a navigational aid. This action is unlawful and dangerous for other boaters.

### Buoys

Most anchored floating markers are generally referred to as buoys. Buoys have many uses and color schemes, and can vary in size and shape. The most commonly used buoy colors are white, red, green, yellow and black. Buoys may be unlighted or lighted. Some are audible; others have both an audible and a visual signal. Lights, bells and horns on buoys aid in night boating or poor visibility conditions. Buoys with unique light-flashing characteristics are identified on nautical charts with the specific flashing pattern.

Become familiar with the specific buoys used in the waters where you are boating. Contact local authorities for specific information and/or navigational aid charts for your waterways.

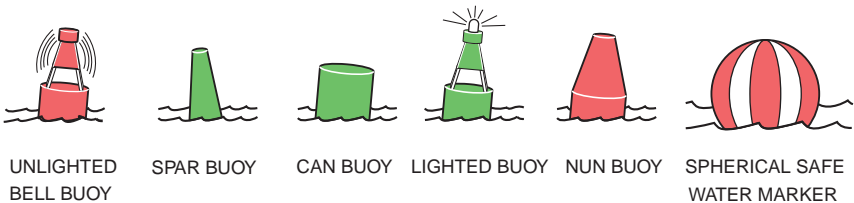

KC-0052C-B

**Figure 7-4**

## Mooring Buoys

The only buoys you are permitted to moor to are mooring buoys. Mooring buoys are white with a blue horizontal stripe. Mooring to a navigation buoy, regulatory markers or lateral markers is illegal.

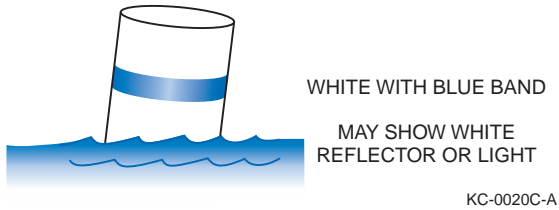

**Figure 7-5**

## Daymarks / Dayboards

Daymarks or dayboards are fixed visual markers in the water. The markers are commonly attached to a post or piling and are sometimes accompanied by a light. Daymarks are either red or green and are usually triangular- or square-shaped, though their shapes can vary. Daymarks often display numbers, which act as navigation guides. Red daymarks are usually triangular and sometimes show an odd number. Green daymarks are usually square and sometimes show an even number. The numbers on the markers are sequential and increase from seaward.

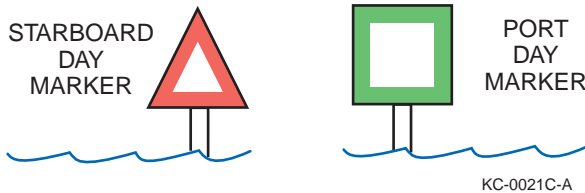

**Figure 7-6**

## Lights and Lighted Structures

Maneuvering a boat at night can be dangerous and confusing. To aid boaters with navigation and to warn of hazards, the USCG and state and local authorities maintain a variety of light structures. Some light structures are equipped with radio beacons, radar reflectors and/or fog signals.

### Range Lights

Range lights are usually visible in one direction and help a boat operator navigate safely. Steering a course to keep range lights arranged in a line (one on top of the other) will help guide a boat through a channel.

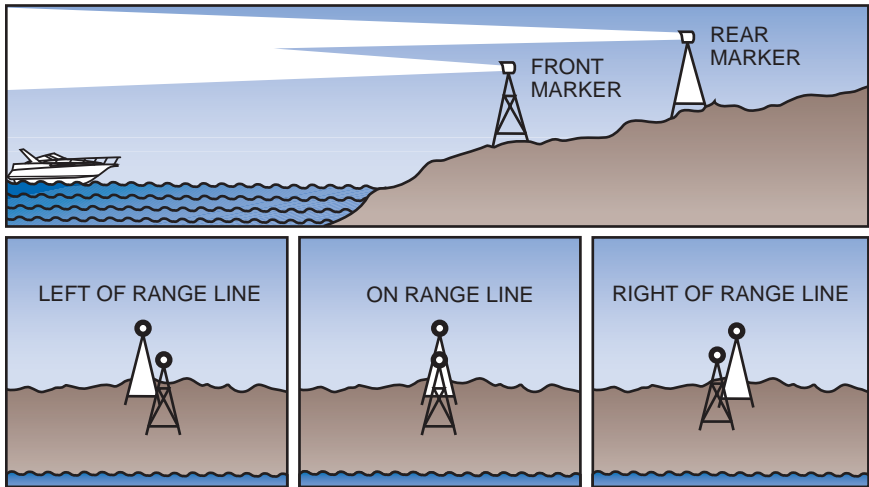

KC-0022C-A

**Figure 7-7**

### Minor Lights

Minor lights are colored according to the buoyage marking system in use. They are similar to lighted buoys, except they are usually higher and on more stable platforms to increase visibility. Most minor lights are part of a series to mark a channel, river, or harbor and fairways.



## Lighthouses

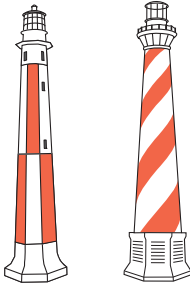

KC-0023C-B

Lighthouses can be found at harbor entrances, prominent headlands, isolated danger areas and along the coasts. These striped or patterned structures have unique flashing signals, which help boaters identify them.

## Markers

Seven (7) types of markers are used to assist the boat operator:

- Range
- Special
- Regulatory
- Safe Water
- Lateral
- Preferred Channel
- Isolated Danger

## Range Markers

Range markers have many color schemes, may have numbers or letters and may be lighted or unlighted. They are placed in pairs within close distance of each other. They are commonly used in channels to guide boats safely through the center or safe line of navigation. Keep range markers visually in line with each other while navigating the waterway to avoid obstacles or other invisible dangers.

## Special Markers

Special markers are yellow and come in various styles and shapes. Lighted and unlighted daymarks and buoys vary in function. Many are used to display information and navigational direction rules. The most common special markers are those used in intercoastal waterways. Contact your state and local authorities for more information on special markers used in your boating area.

## Regulatory Markers

Regulatory markers are used to display information or indicate danger. Regulatory markers can be fixed visual markers or anchored floating buoys.

Fixed visual markers are usually white with orange geometric shapes that display information. Anchored floating buoys are white cylinder-shaped buoys with orange bands at the top and orange geometric shapes that may display information.

Following are the various orange geometric shapes used on these markers:

- Diamond – Indicates danger
- Diamond with cross marks inside – Indicates that a boater must keep away
- Circle – Indicates a controlled area or speed limit
- Square – Displays important information

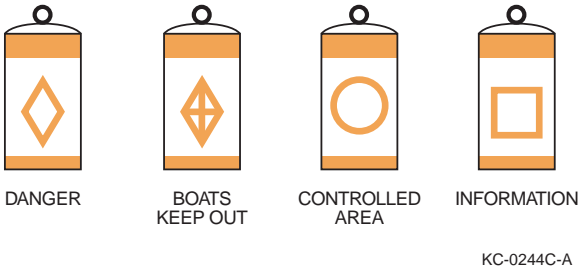

**Figure 7-8**

## Lateral Markers

Lateral markers are used to mark the sides of navigable channels. They can be buoys, daymarks or minor lights, and are red and green in color. They can be lighted or unlighted and may or may not have numbers.

The basic nautical rule of lateral markers is the phrase “Red, Right, Returning.”

The term “sea” generally refers to the ocean or a large body of water. “Seaward” refers to traveling from the sea or a large body of water inland or to a smaller body of water.

When traveling seaward – keep red markers to your port (left) and green markers to your starboard (right).

When returning from seaward – keep red markers to your starboard (right) and green markers to your port (left).

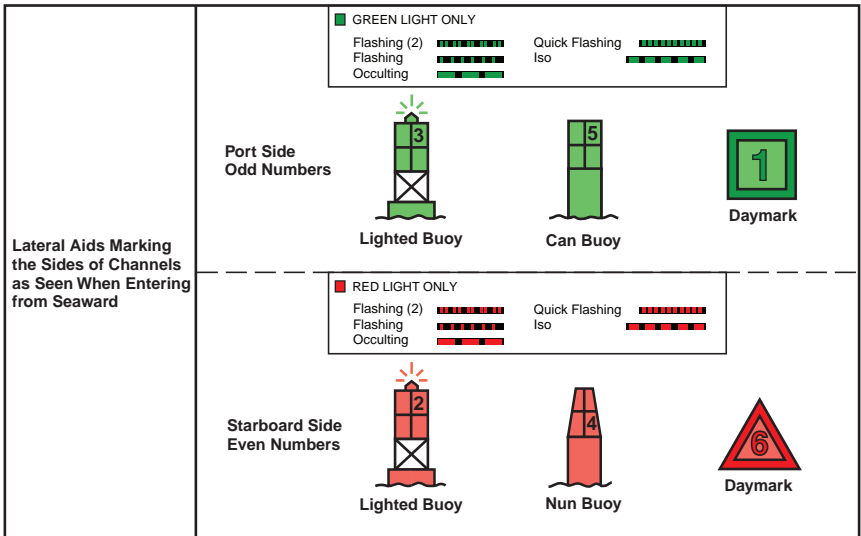

KC-0054C-A

**Figure 7-9**



## Isolated Danger Markers

Isolated danger markers indicate an isolated danger which may be passed on all sides. These markers are black with one or more broad horizontal red bands and are equipped with a top mark of two black spheres, one above the other. On inland waters, a buoy with alternating vertical black and white stripes may be used to indicate that an obstruction or other danger exists between the buoy and the nearest shore. Do not pass between the buoy and the shore.

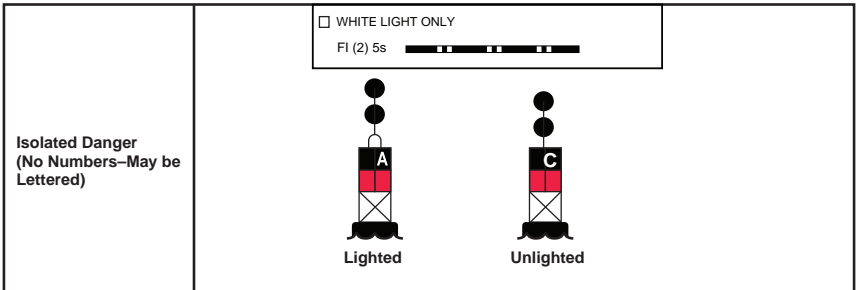

KC-0057C-A

**Figure 7-12**

## Other Special Signs And Markers

Various signs and markers are used throughout U.S. waterways for different purposes. In Florida, special signs are used to warn of “manatee” areas. These signs help to control speed and/or restrict areas from boating to conserve this endangered species. As a boat owner and operator, be aware of special information and markers on the waterways. Contact your state and local authorities for more information on local restricted or controlled areas and their markers.

**This Page Intentionally Left Blank**

# CENTURION BOATS

## Section 8

# CONTROLS, FEATURES AND OPTIONS

This section includes general and specific information about major systems and components that may be standard, optional or not applicable on your boat. For specific information on the systems and components in your boat, see your local Centurion dealer.

## TOW BOAT TECHNOLOGY

Your boat may be equipped with one or more of the following features engineered specifically for towing.

### Touch Vision Dash

Easy to use and engineered for the harsh environment, the Patent Pending Side-by-Side Touch Screen offers a refined look that is seamlessly integrated into the dash. The Side-by-Side screen offers the driver control over ballast configurations, CATS, Rider Presets, GPS cruise control and much more. Working together, the Side-By-Side displays are able to transfer information across from one screen to another.

See separate Touch Vision II system and Side-by-Side touch screen Owner's Manuals for operation.

## Touch Vision Side-by-Side Display



Figure 8-1

## CATS (Centurion Articulating Tracking System)

### What it does:

Through the steering column lever or Touch Vision Screens the CATS fin articulates under the boat on command. While the boat is underway, the CATS fin can be manipulated into the position desired to change the direction of water flow helping the driver create a better surf and wakeboard wave. The CATS fin also allows the driver to level the boat even with an offset in weight.

### How it Works:

The Tracking Fin that moves under the boat is positioned through a cut out in the gas tank. The Rod that sticks through the boat is attached to a ram that moves the fin right or left. The ram is controlled by one of the 3 PDM's in the boat. The Touch Screen relays a signal to the computer to know when you, the driver, want to position the CATS differently.

See separate Touch Vision II system and Side-by-Side touch screen Owner's Manuals for operation.



## Ramfill

Ramfill is a ballast system integrated into the hull liner that is quick to fill and quick to drain, without the need of pumps or sacs. The system consists of an underwater scoop, side air vents and drain valves and is controlled and monitored by the Touch Vision II system with Side-by-Side touch screen. The ballast system will vent air and overflow water out the side vents of the boat, and is emptied from the transom drains.

See separate Touch Vision II system and Side-by-Side touch screen Owner's Manuals for operation.

## Ramfill System



*Figure 8-2*

## Plug N' Play Ballast System

The Plug N' Play Ballast system uses four transom-mounted pumps that are reversible for filling/drainage. The pumps enable 4 separate ballast tanks to be filled or drained independently. The pumps are marked on top as to what ballast tank they fill/drain. The pumps fill/drain three soft bagged Fly High ballast sacs (one located in the bow of the boat and two located in the rear port and starboard motor compartments). The fourth ballast pump fills/drains the center hard tank which is located subfloor under the walk over ice chest.

### QuickSurf Pro

Quicksurf Pro is a wakesurf system attached to each side of the transom used for making and shaping the Surf Wave. The plates, which can be adjusted to different angles allow for a controlled wave size and shape.

On an equally weight-distributed surf boat, the system can allow for a driver to shift a surf wave from port to starboard with just a press of a button on the Touch Vision II system with the Side-By-Side Screen. The Quicksurf Pro can be used in combination with the Stinger Wake Plate to tune the wave, or Quicklaunch to get the boat to plane quickly without bow rise.

See separate Touch Vision II system and Side-by-Side touch screen Owner's Manuals for operation.

### Quicksurf Pro



*Figure 8-3*

### Stinger Wake Plate

The Stinger Plate is a large center plate located off the transom of the boat. The plate helps produce lift during the Quicklaunch sequence. The plate also helps form a more steep or mellow wakeboard/surf wave depending on the location of the plate in the up or down position.

## Silent Stinger Wake Plate

The optional silent stinger wake plate operates the same as the standard stinger plate except that the engine exhaust is routed to the plate further diffusing the exhaust note with water.



*Figure 8-4*

## Maximus Tower

The Maximus tower by Roswell™ can be quickly raised / lowered by one person using the Port and Starboard cam latches. The tower can be optioned with a variety of accessories including, but not limited to, clamping board racks, bimini top, DownFire™ Speakers, and much more.

**CAUTION! The Maximus Tower is not designed to pull Inflatables\*.**

See separate Maximus Tower Owner's Manuals for operation and accessory details.

## Downfire Audio System

The Downfire marine audio system by Roswell™ has two distinct volume zones.

See separate Maximus Tower Owner's Manuals for operation and accessory details.

## STEERING SYSTEM

A mechanical-type rack and pinion steering system is used to transfer the helm rotary movement to linear motion in the cable which pushes or pulls the rudder arm and rudder to change the direction of the boat.

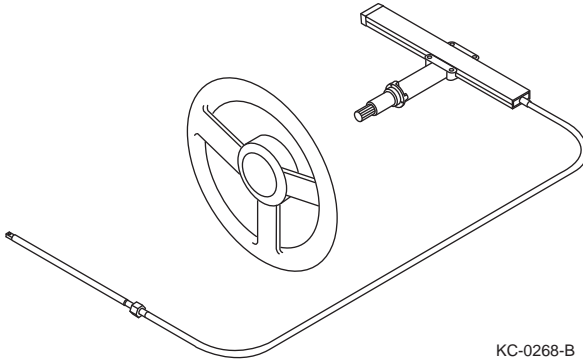

**Figure 8-5**

## HELM

The following basic information may not apply to your specific boat. This section may not cover all gauges on your boat. See the *Engine Operator's Manual* or equipment manufacturer's supplied information on the use and operation of the unique gauges and instruments. Some models may be equipped with a multi-gauge instrument which integrates the functions of several single gauges.

Gauges are visual indicators that help you monitor various system and component operation parameters. Gauges usually have lights integrated into them for visual clarity when operating at night. They are located near the helm area or other main control areas.

## Shift and Throttle Control

Knowing how to operate the shift and throttle controls of your boat is essential for safe and proper operation.

The following basic and typical information may not apply to your specific shift control. See the *Engine Operator's Manual* or control manufacturer's instructions for information on your throttle and shift control operation, adjustment and maintenance.

Single-lever controls operate both the gear shift and the throttle for one engine with one control lever.

- **NEUTRAL** - The lever is detented in the **NEUTRAL** position (center of travel) for starting; the neutral safety switch allows starting in this position only. For engine warm-up, a separate lever or button on the control is used to allow the throttle to advance only while the transmission remains in **NEUTRAL**.
- **FORWARD** - Release the detent lock to allow shifting to the **FORWARD** position. Moving the lever into the first 15° of travel (toward the bow or up) positions the control in the **FORWARD** detent **IDLE** position. Advancing the lever beyond 15° allows throttle increase in **FORWARD**.
- **REVERSE** - Release the detent lock to allow shifting to the **REVERSE** position. Moving the lever into the first 15° of travel (toward the stern or down) positions the control in the **REVERSE** detent idle position. Advancing the lever beyond 15° allows throttle increase in **REVERSE**.

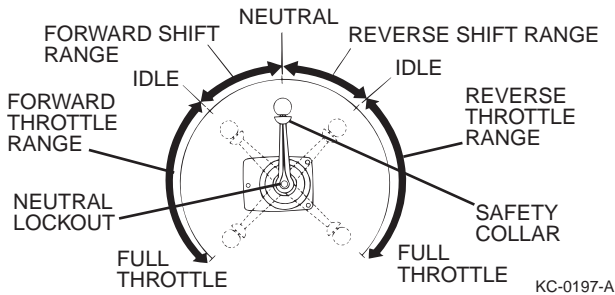

**Figure 8-6**

## Typical Shift and Throttle Control



**Figure 8-7**

## Control Operation Guidelines

**WARNING! Improperly maintained controls are hazardous and may cause sudden loss of control. Make sure all shift/throttle hardware and cables are regularly inspected and maintained. Improper maintenance may result in a loss of control, resulting in serious injury or death.**

- Most throttle and shift controls have a neutral detent locking lever that must be released before shifting from NEUTRAL.
- Always pause in NEUTRAL before shifting from FORWARD to REVERSE, or REVERSE to FORWARD. Most throttle and shift controls have a detent position for NEUTRAL, FORWARD and REVERSE engagement positions. Engine damage may occur if you rapidly shift into gear without pausing or allowing the engine RPM to lower into the approved shifting range.
- When traveling at high speed, never shift into REVERSE while the boat is in FORWARD gear.
- Always keep the shift control clean and clear of obstructions. *NOTICE: All shift and throttle controls are equipped with a safety switch for start-in-gear prevention. Place the control in the NEUTRAL position before you attempt to start the engine.*
- Never attempt to shift when the engine is not running.

## Centurion Dash

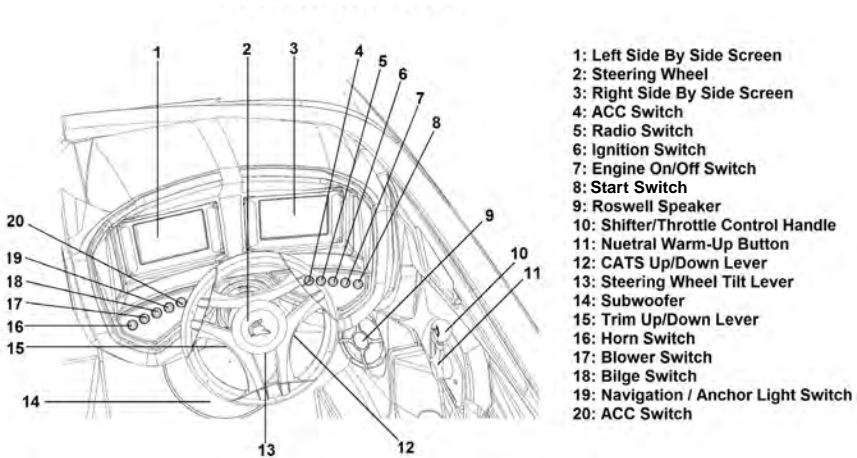

Figure 8-8

## Speed Control System Gauge

Your boat may be equipped with an optional speed control system. (Control systems and indicators may vary.) The speed control system can be used to set constant boat speeds for wakeboarding, water-skiing or wake surfing. The system may operate in either a speed or RPM mode to control the speed at the setting you prefer. See the *Touchvision II System and Side by Side Touch Screen Owner's Manual* in your *Owner's Information Kit* for proper setup and operation before use.

# SWITCHES AND BREAKERS

The number and type of switches and circuit breakers on your boat will vary by model and options. The following is a general reference for typical layouts.

## Observer Seat Storage Compartment

- **Battery Switch** - makes or breaks electrical power from the battery to all boat systems except the Bilge Pump.
- **Buss Switch** - makes or breaks electrical power from the battery to the network buss.
- **Bilge Pump Circuit Breaker** - disconnects power to the bilge pump should an overload occur. If the bilge pump does not work, check for the cause and press to reset.
- **Digital Switch Breaker** - disconnects power to the helm switch panels should an overload occur. If a switch does not work, check for the cause and press to reset.

## Battery Management Center



*Figure 8-9*

## Power Switch Panel

The power switch panel is located at the helm and uses a key switch to turn power to dash and controls ON and OFF.

- **Power Switch** - makes or breaks electrical power from the battery to the helm.
- **Kill Switch** - an important safety feature that uses a lanyard attached between the switch and the operator to prevent a runaway boat situation should the operator move from the helm or get thrown from the boat. Refer to Section 3 Safety for more information.
- **12 VDC Accessory Port** - use for standard 12 volt accessories.



## Typical Power Switch Panel



*Figure 8-10*

## Port Switch Panel

- **Horn** - press and hold to activate horn.
- **Blower** - press and release to activate blower. Press and release again to turn blower off.
- **Bilge** - press and release to activate bilge pump. Press and release again to turn pump off.
- **Nav/Anch** - press and release once to activate anchor light, twice to activate navigation lights, and three times to turn off lights.
- **ACC** - used to control power to an added accessory. Press and release to power accessory. Press and release again to turn power off.

## Typical Port Switch Panel



*Figure 8-11*

## Starboard Switch Panel

- **Start** - press and hold to start engine.
- **Eng/Off** - press and release to stop engine.
- **Ignition** - press and release to power the Touch Vision side-by-side displays. Press and release again to turn displays off.
- **Radio** - press and release once to power radio. Press and release again to turn radio off.
- **ACC** - used to control power to an added accessory. Press and release to power accessory. Press and release again to turn power off.

### Typical Starboard Switch Panel



Figure 8-12

## CATS Switch

The CATS switch panel is located on the starboard side of the steering wheel. Operate lever down to refine the shape of the wave as desired.

### CATS Switch



Figure 8-13

## Engine Emergency Stop Switch and Lanyard

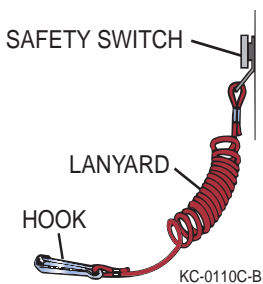

The engine emergency stop switch controls the engine ignition ON/OFF. This safety device shuts the engine off immediately and prevents the boat from becoming a runaway if the operator is accidentally thrown from the seat or away from the helm.

Whenever your boat's engine is on, physically secure one end of the emergency engine stop switch lanyard to the emergency stop switch and the other to the boat operator. If the operator is thrown from the seat or moves too far from the helm, the lanyard will disconnect from the switch, activating the switch to turn off the engine.

- Never remove or modify the engine emergency stop switch and/or lanyard.
- Always keep the lanyard free from obstructions that could interfere with its operation.
- Always check the switch for proper operation. With the engine running, pull the lanyard. If the engine does not stop, have the switch repaired before operating your boat further.
- Never operate your boat if the engine emergency stop switch does not work.  
**WARNING! Removing the engine stop switch and/or the lanyard can cause loss of control. See Safety Precautions in the Safety Section of this manual for more details.**

## Neutral Start Safety Switch (Start in Gear Prevention)

The neutral start safety switch provides start-in-gear prevention. The switch controls power to the engine starter circuit of the ignition switch. The engine gear shift control lever must be in the NEUTRAL position to allow the ignition switch to activate the engine starter. This safety device will prevent the boat's engine from starting if the engine is in gear.

## Navigation Lights Switch

The navigation lights switch is an ON/OFF push button on the left dash panel. The ANCHOR position is used when your boat is at rest after dark in open waterways. In this position only will the 360° tower light or pole light will be illuminated. When your boat is under way between sunset and sunrise, the switch must be placed in the NAVIGATION position. This will activate both the 360° tower and/or pole light, but also the bow red/green running lights. *NOTE: Boats not equipped with towers are not equipped with international lighting for use in coastal waters.*

Never operate the boat between sunset and sunrise using only the stern light. Use all navigational lights when operating under way between sunset and sunrise. For additional information, see *Navigational Lights & Night Operation on page 7-2*.

### **Blower Switch**

The blower switch is used to activate the engine compartment blower. When in the ON position the blower will help to eliminate any fumes from the engine compartment. **WARNING! Gasoline vapors can explode. Before starting the engine, operate the blower for four minutes and check the engine compartment for gasoline leaks and vapors. Always run the blower below cruising speed.**

### **Bilge Pump Switch**

The bilge pump switch is used to activate the bilge pump. When in the ON position the bilge pump is activated to pump out any excess water in the bilge area. The bilge pump also has a float switch that automatically turns on when the water level rises approximately 1.5 in. or more in the bilge area.

### **Horn Switch**

The horn switch controls power ON/OFF to sound the horn.

### **Courtesy and Docking Light Switch**

These lights are controlled by the Touch Vision II system. See separate Owner's Manual for operation. Do not use courtesy or docking lights while operating your boat above idle speeds.

### **Tower Light Switch (Optional)**

These lights are controlled by the Touch Vision II system. See separate Owner's Manual for operation.

### **Trim Tab Switch (Optional)**

The trim tab switch controls the up or down movement of the stinger wake plate.



Figure 8-14

## Ballast Tank Switch (Optional)

Ballast tank filling and draining is controlled by the Touch Vision II system. See separate Owner's Manual for operation.

## Cockpit Heater Switch (Optional)

The heater switch turns on the optional cockpit area heater blower. For additional information on the cockpit heater system, see *Cockpit Heater System (Optional)* on page 8-25 and the *Heater System Operator's* manual.

## FUEL SYSTEM

Basic fuel systems consist of one or more fuel tanks, tank vents, a level sensor and gauge, lines, pumps and valves.

Each tank has an antisiphon valve to prevent fuel from leaking out of the tank should a break occur in the system at a point other than the tank.

## ENGINE COOLING SYSTEM

Marine inboard engines may be cooled in different ways. Depending on your engine application, an open or self-contained cooling system may be used.

An open cooling system uses raw water (seawater) to cool the engine and/or drive system. A continuous flow of raw water is used to transfer heat from the engine and drive cooling passages and is then returned to the sea. A seacock and raw water pickup on the hull allow water into the engine, and a pump then circulates the water to cool the engine.

### Seacock

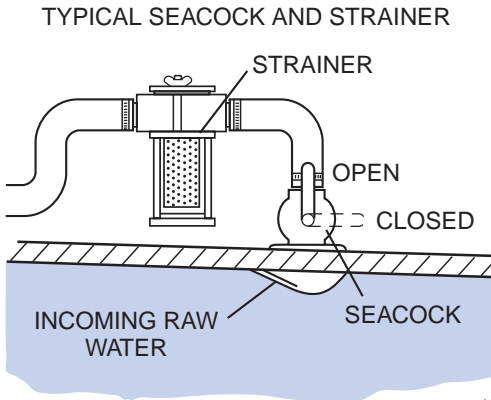

**Figure 8-15**

A self-contained/closed cooling system uses raw water to cool the engine and/or drive system through the use of a heat exchanger. A continuous flow of raw water is used to transfer heat from the heat exchanger to cool the engine and drive coolant. The engine cooling passages and heat exchanger passages are self-contained/closed, similar to an automotive cooling system. Heat is transferred from the engine and drive to the coolant and circulated through the heat exchanger in the closed system. A separate raw water passage in the heat exchanger is used to transfer heat from the self-contained engine coolant to the raw water. The raw water is then returned to the sea.

Raw water intakes on the hull use a seacock to provide manual shutoff if a leak occurs. Periodically inspect the raw water intake screen (if equipped) and clear it of debris that could obstruct water flow into the engine. **NOTICE:** *Keep seacocks closed during periods of inactivity. A downstream hose failure could flood the boat if the seacock is left open. Open seacocks only when necessary.*

## ENGINE EXHAUST SYSTEM

The engine exhaust system vents engine exhaust gases away from the boat. Inboard engines may use mufflers and/or seawater to cool part of the exhaust system. Do not make changes or modifications to the exhaust system. See the *Engine Operator's Manual* for engine exhaust system and service information.

## ENGINE LUBRICATION SYSTEM

Inboard engines, like automotive engines, use a sump system where the engine oil is contained in the engine. See the *Engine Operator's Manual* for engine oil recommendations and service information.

## ELECTRICAL SYSTEM

### DC System

Most boats use a 12-volt common negative ground DC system. DC systems are usually the primary electric supply for lights, pumps, blowers, engine starting, etc.

One battery is required at minimum for engine starting and accessory power. Multiple-battery systems consist of a primary engine starting battery and additional batteries that supply additional power to DC electrical accessory circuits.

Battery switches control battery power distribution and disconnect the batteries from the boat's electrical system. The engine's charging system charges batteries connected to the charging system when the engines are running.

Battery isolators prevent accessory loads and other batteries from depleting power from charged batteries. Isolators also allow the engine's charging system to isolate the alternator charging output and distribute the charge among all batteries according to individual need.

Where applicable, a main DC control panel may feature a voltmeter, battery test switch, fuses, circuit breakers and a master breaker switch. **WARNING! Never reset a breaker that has been automatically tripped without first identifying and correcting the cause of the problem. A fire could result. See Safety Precautions at the beginning of this section for more details.**

## Batteries

Centurion Boats come standard with Dual batteries along with a Battery Switch that allows for “OFF/ON/COMBINE” functions. “ON” should be used for normal operation of the boat. “COMBINE” should only be used to jump start the boat in emergency situations. If listening to the stereo without the motor running make sure the Battery switch is only in the “ON” position. This way if the battery dies, you can still flip the Battery switch to “COMBINE” to start the motor. The battery switch is located under the Observer seat.

### Dual Battery Setup

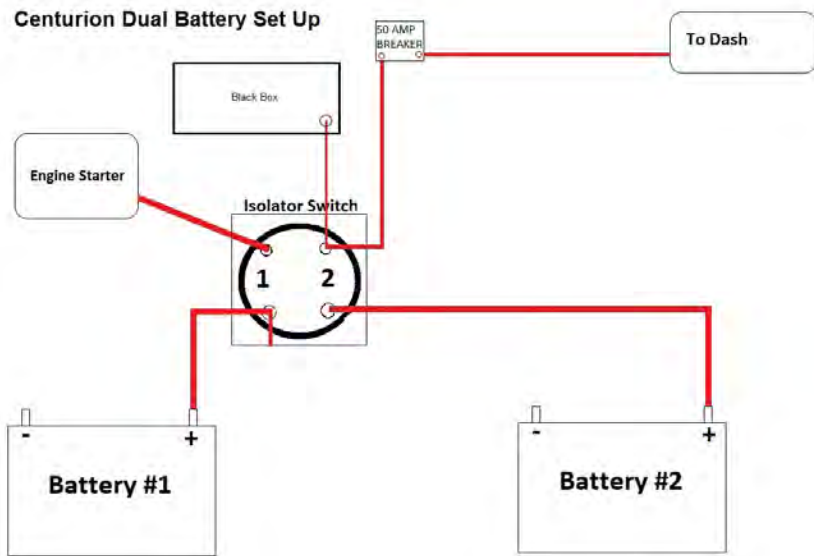

Figure 8-16

## BILGE PUMP SYSTEM

The Federal Water Pollution Control Act prohibits the discharge of oil or oily waste into the water. Violators can be fined \$5,000.

Water will enter the boat for a number of reasons, including heavy seas, long periods of rain, or leaking seacocks or fittings. The bilge area is usually the deepest part of the hull where the water settles. The bilge pump moves water from the bilge area through hoses and empties it through an opening in the hull.



An automatic bilge pump system features automatic activation of the bilge pump by use of a float switch in the bilge area that, when activated, turns the pump on to allow water to be pumped out. The bilge pump can also be operated manually by a switch at the helm. **NOTICE:** *Do not allow the bilge pump to operate after all the water has been cleared from the bilge area; damage to the pump will occur if you operate it without water. Periodically check the bilge area and float switch and remove any debris that may clog the pump or render the float switch inoperative.*

## **BALLAST TANK SYSTEM (OPTIONAL)**

The purpose of ballast tanks is to add weight to the boat in designated areas to help produce larger wakes for water sport activities, such as wakeboarding and wake surfing.

The ballast system consists of water tanks, pumps, seacocks, hardware and controls. Panel-mounted switches activate water pumps that fill and drain the tanks with seawater. Seacocks are used to open and close seawater drains.

**DANGER!** *Never add additional ballast. Additional ballast can make a boat unsafe and illegal to operate.*

**WARNING!** *When the ballast tanks are filled, reduce the total weight in the boat. By adding ballast, the boat becomes heavier and fewer passengers and/or gear are allowed in order to keep the boat within legal and safe weight limits. The average passenger weighs 141 lb (64 kg). Water weighs approximately 8.4 lb per gallon (1 kg per liter). Fuel/gasoline weighs approximately 6.3 lb per gallon (0.75 kg per liter).*

See separate *Touch Vision II Owner's Manual* for ballast tank system operation.

## Typical Ballast Tank Locations

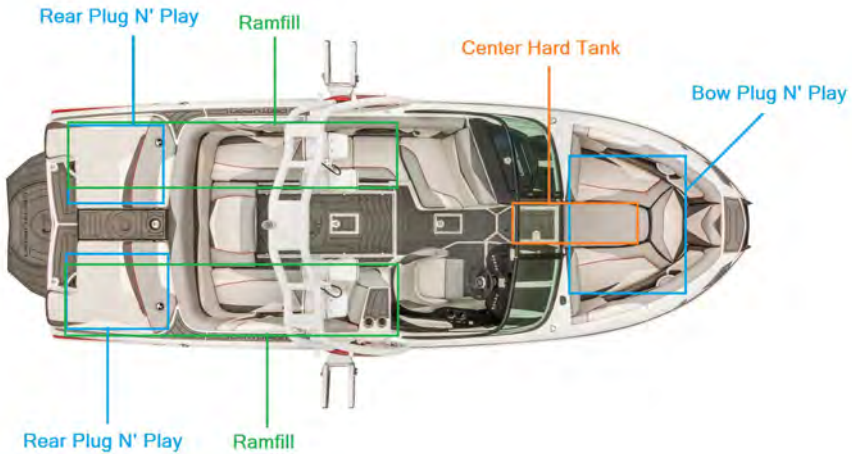

Figure 8-17

## RAMFILL BALLAST OPERATION

The Ramfill ballast system valves will not open unless the boat is over 10 mph and under 25 mph. The faster the boat speed (20-25 mph), the faster the fill and drain. The Ramfill system is controlled by the Touch Vision Side-by-Side Dash display. See the Touch Vision Operator's Manual for more information.

To fill the ballast tank:

1. Navigate the boat to open water that is free of other traffic.
2. Pull-up the Ramfill menu on the Touch Vision display.
3. Select a pre-set or Manual fill option.
4. Shift to Forward and accelerate to between 10 and 25 mph.
5. When the ballast tank levels shown on the Touch Vision display reach the desired level, turn Ramfill off.
6. The boat is now ready for tow sports.

To fill the ballast tank:

1. Navigate the boat to open water that is free of other traffic.
2. Pull-up the Ramfill menu on the Touch Vision display.
3. Select the Ramfill Drain option.
4. Shift to Forward and accelerate to between 10 and 25 mph.
5. When the ballast tank levels shown on the Touch Vision display show empty, turn Ramfill off.

## PROPELLER STRUT

The propeller shaft is supported on the outside of the hull by a strut. The strut integrates a composite bearing supporting and allows the propeller shaft to rotate in the strut.

*NOTICE: The propeller shaft strut bearing is lubricated by water. Do not shift the transmission and run the propeller out of the water, even if water is supplied to the engine's cooling system. Damage to the shaft and bearing can occur.*

### Typical Propeller and Strut



CNTRN-0021C-A

**Figure 8-18**

## PROPELLER

The propeller converts the engine's power into the thrust needed to propel the boat. Care and selection of your propeller is very important for proper boat operation. Propeller size is usually identified by three numbers, such as 13 x 16 x 1-1/8, and a material identification, such as brass, aluminum or stainless steel. In the number sequence, the first number is the diameter of the propeller in inches and the second is the pitch in inches and the third number is the diameter of the propeller shaft.

Pitch is the angle of the blades expressed in the theoretical distance a propeller travels in each revolution. In the above example, the pitch is 16, which means that each revolution of the propeller pushes the boat 16 inches (406 mm) through the water.

It is recommended that the boat be removed from the water for propeller replacement, as the propeller is not easily accessible while the boat is in the water. A special puller and tools are required to remove the propeller in most applications.

Always consult your local marina or certified marine technician for assistance when replacing or servicing propellers.

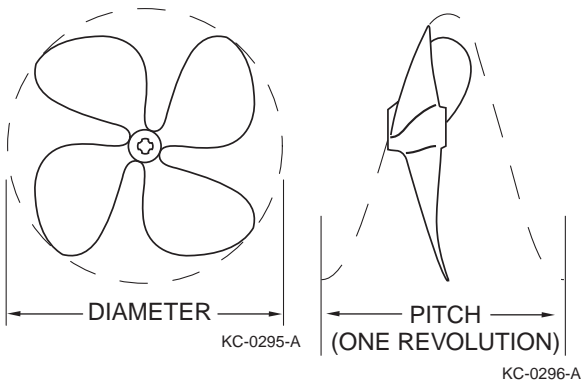

**Figure 8-19**

## Propeller Selection and Replacement Guidelines

There are many different propeller designs for specific operating characteristics.

It is highly recommended that you arrange for your dealer to perform any propeller service, removal or installation procedures.

To prevent personal injury and/or equipment damage, follow these guidelines before installing or removing the propeller:

- Remove the boat from the water into a position where the propeller is accessible.
- Position the shift control in NEUTRAL.
- Position the battery switch to the OFF position or remove the negative battery cable from the engine starting battery to ensure the engine cannot accidentally start.
- Place a wood block between the boat hull and the propeller to hold the propeller in place while removing the propeller nut. **WARNING! Never use your hand to hold the propeller when removing the propeller nut.**
- When removing the propeller, use a propeller puller to remove the propeller following the puller manufacturer's instructions.
- When installing the propeller, verify that the propeller is tight on the shaft and the propeller nut is torqued to the correct specification.

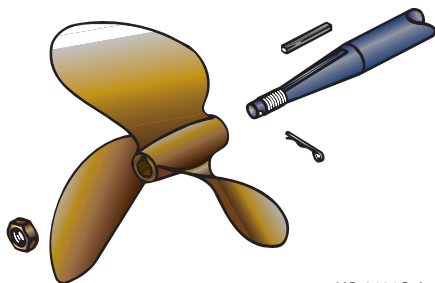

KC-0191C-A

**Figure 8-20**

# ENGINE COMPARTMENT VENTILATION SYSTEM

Ventilation or blower systems are designed to remove explosive vapors that accumulate in the bilge area and engine compartment. Proper ventilation is extremely important to personal safety while boating.

Powered ventilation systems consist of one or more sealed fans that replace vapors with fresh air through intake and exhaust vents. Always operate the blower for at least four minutes before you start the engine. You should also operate the blower continuously when at idle and during slow-speed operation.

Natural ventilation systems also have intake and exhaust vents; as the boat moves, air is forced into the intake vent and escapes through the exhaust vents.

The engine compartment cover is a structural part of the boat and acts as a machinery guard. The engine cover must be in place and closed whenever the engine is running. DO NOT operate your boat with the cover open or with the engine exposed. **WARNING! Contact with moving parts can entangle, cut and can cause death or serious injury. Never make contact with any running machinery moving parts, such as the engine or propeller.**

# TRIM TAB/STINGER WAKE PLATE (OPTIONAL)

Trim tabs are either power or manually controlled. (Equipment will vary by model and options.) A powered trim tab is controlled from the helm by a switch and use of a position indicator. A cavitation plate is controlled by manually adjusting the plate adjustment rods to a predetermined position.

A trim tab enhances the planing ability of the boat. When used on inboard ski boats a single trim tab is used to enhance and control the type of wake desired by controlling the hull running attitude.

By controlling the wake characteristics, wakes can be made to enhance water sports such as wakeboarding, barefooting, kneeboarding and towables.

A single tab is usually mounted in the center rear of the hull. Tab movement is controlled from a helm-mounted switch, which activates an electric or electric/hydraulic actuator attached to the tab.

When operating at wakeboarding speeds, with the trim tab in the UP position, the bow rises and the hull rides normally, creating heavy water displacement and large wakes.

When operating at skiing speeds, with the trim tab in the DOWN position, the bow lowers and helps the boat to plane quickly for skiing and slalom skiing-type wakes and allows for pulling more and/or heavier skiers.

See the *Trim Tab Operator's Manual* for additional information.

## Typical Power Trim Tab



*Figure 8-21*

## WAKE TOWER (OPTIONAL)

Wake towers are used to provide a higher towing point for water sports and to mount lights and other accessory equipment. Towers are solidly constructed from stainless steel or aluminum and are mounted solid to the boat. Some towers may have an optional folding feature, which allows the tower to be folded for storage or clearance. **WARNING! Misuse or overloading of the wake tower can cause death or serious injury. The wake tower is designed for water sports only. DO NOT use for towing other watercraft, parasailing, kite flying or towing tubes or other similar towables. Read the safety decal on the wake tower before using and DO NOT overload the tower's weight rating.**

## COCKPIT HEATER SYSTEM (OPTIONAL)

A marine heater uses the heated engine coolant to produce forced air heat through a ducted location in the boat or through a snorkel-type tube. Heated engine coolant is circulated through a heater core and an electric blower fan moves air over the heater core, transferring heat from the heater core to the ducted area air in the boat or on the windshield. Where applicable, the snorkel tube can be moved anywhere within its reach to provide an isolated heat duct. A helm or remote panel-mounted ON/OFF switch operates the heater blower fan.

See the *Marine Heater Operator's Manual* for further information.

**This Page Intentionally Left Blank**



# CENTURION BOATS

## Section 9

# OPERATING YOUR BOAT

Before operating your boat, see *Safety* on page 3-1.

## SAFETY PRECAUTIONS



### WARNING

**These safety messages describe hazardous situations which, if not avoided, could result in death or serious injury.**

#### **Runaway Boat Hazard**

**Certain actions can cause you to lose control of your boat.**

- When accelerating the boat in the forward direction, the bow can rise and restrict visibility. Observe for obstacles and people before accelerating.
- If you lose control of the boat, pull back on the throttle.

## BEFORE GETTING UNDER WAY

### **Safety Equipment**

Federal and local laws require certain safety equipment to be on-board at all times. Responsible boaters carry additional equipment in case of emergency.

### **Filing a Float Plan**

Complete a float plan before departure and leave it with a reliable person who is aware of your intentions while on the water. In case of emergency or if you do not return as planned, this information can be helpful to the USCG or others in rescuing or contacting you. For more information on float plans or to download a float plan form, visit the U.S. Coast Guard Auxiliary website at:

<http://www.floatplan.uscgaux.info>.

### Pre-Departure Safety Checklist

The following checks are essential to safe boating and must be performed before starting the engine or getting under way. Perform these checks every time you operate your boat so they become routine.

Never launch the boat or leave the safety of the dock if any problem is found during the pre-departure safety check. A problem could lead to an accident during the outing, causing severe injury or death. Have any problems corrected before proceeding.

- Check the current and forecasted weather reports, as well as wind and water conditions.
- Make sure the operator is qualified and does not use drugs or alcohol while at the helm.
- Make sure all required safety equipment is on-board.
- Make all passengers aware of safety procedures.
- File a float plan.
- Have all required documents on-board.
- Have all maps or navigational charts for the intended destination on-board.
- Be sure all passengers are properly seated.
- Be sure the boat is not overloaded.
- Check the engine emergency stop switch lanyard for proper installation and operation.
- Be sure the fire extinguisher is fully charged.
- Have plenty of emergency food and water on-board.
- Be sure all required equipment is on-board (mooring lines, anchor lines, tool kit, etc.).
- Be sure you have enough fuel for the return trip.
- Be sure no person or obstacle is near the propeller.
- Check that all required maintenance has been performed.

#### Check the following engine and boat related items:

- Check that throttle/shift control is in the NEUTRAL position.
- Inspect the steering, throttle, and shift cables for kinks, wear and interference with other components.
- Check the engine cooling water intake pickup and strainer for blockage.
- Check that batteries are fully charged and the battery terminals are clean and tight.
- Check the electrical systems and navigation lights for proper operation.
- Check bilge drain plugs for proper installation.
- Be sure all water has been pumped from the bilge area.
- Check the bilge blower for proper operation, and be sure no fumes are present in the bilge area.

- Check that no fuel, oil or water is leaking or has leaked into the bilge compartment.
- Check all hoses and connections for leakage and damage.
- Check the hull and propeller for damage.
- Check the V-Drive fluid level.
- Check the engine belts for looseness or damage.
- Inspect the exhaust system for leaks.
- Inspect the propeller shaft seal for excessive water entry.
- Inspect the drive train for loose or missing hardware.

## Boarding

Helpful guidelines when boarding a boat:

- Always step, rather than jump, into a boat.
- Avoid stepping on fiberglass or other potentially slippery surfaces.
- Always board one person at a time.
- Never board while carrying gear. Set the gear on the dock, board the boat and then pick up the gear.
- Never use the engine unit as a boarding ramp.
- It is courteous to always ask for permission to board so the owner/operator is aware of your presence on the boat.

## Boat Loading

The safety and performance of your boat depends on the distribution of load and weight.

The person/load capacity is determined by the USCG. A capacity plate is usually located within clear visibility of the boat operator or helm area. The capacity plate indicates limits for loading the boat, which are enforceable by law.

***WARNING! NEVER exceed the USCG certified maximum capacities under any circumstances. Exceeding the limitations stated on the capacity plate can cause the boat to sink or the passengers and/or operator to drown, resulting in death or serious injury.***

- Board passengers one at a time and distribute them equally to maintain equal buoyancy of the boat.
- Distribute weight equally from port to starboard and fore to aft. The shifting of weight may be required when under way to maintain an efficient hull running attitude for optimum performance.
- Stow and secure all loose gear in storage areas to prevent load shifting.
- Do not stow gear on top of safety equipment; safety equipment must be quickly accessible.

## Section 9

- In adverse weather, reduce the load in the boat. Person and load capacity ratings are calculated for normal boating conditions.

Be sure all passengers are properly seated and not riding on the bow, gunwale or rear platform while under way. Use caution when riding in the bow. Move to the aft passenger seats during rough water operation.

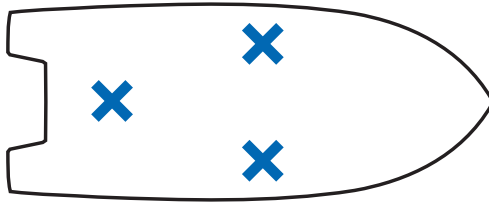

PROPER DISTRIBUTION

KC-0035-A

**Figure 9-1**

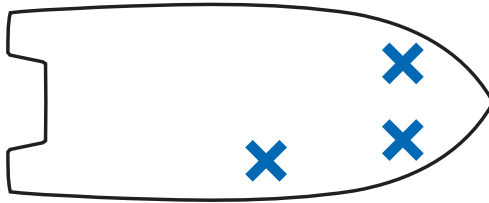

IMPROPER DISTRIBUTION (BOW HEAVY)

KC-0036-A

**Figure 9-2**

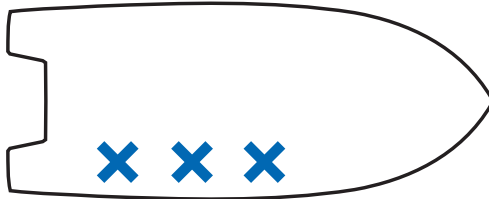

IMPROPER DISTRIBUTION  
(STARBOARD HEAVY)

KC-0037-A

**Figure 9-3**

## Fuel Management

Use the “one-third” rule for fuel management. Use one-third of the fuel to reach your destination, one-third to return and one-third as reserve fuel.

## Fueling

The fuel fillers are located in the aft area on both port and starboard side. The fuel tank is equipped with an antisiphon valve that operates automatically to prevent fuel from draining from the tank in the event of a leak in the fuel system.

Gasoline fumes are heavier than air and will sink to the lowest part of your boat, such as the bilge. Always evacuate fumes with the bilge blower before attempting to start the engine.

*NOTICE: To prevent unwarranted engine damage, see your Engine Operator's Manual for manufacturer-recommended fuel and oil specifications.*

When refueling, observe the following:

- Have a proper and charged fire extinguisher ready. **WARNING! Gasoline is extremely flammable and highly explosive under certain conditions. See Safety on page 3-1 for more details.**
- Secure the boat to the dock.
- Stop all engines, motors and fans before refueling.
- Never smoke or allow open flames or sparks within 50 feet (15 meters) of the fueling area.
- Avoid spills and know how much fuel is already in the tank before adding fuel. Wipe up any spills immediately.
- Always fill fuel tanks slowly. Be aware that if the boat's attitude changes while floating, the fuel level and position change in the tank, which could cause spillage.
- Never overfill the fuel tanks.
- Always allow space (at least 6%) for expansion of fuel in the fuel tank.
- Never pump fuel into an unapproved container.
- Use only fuel approved by the engine manufacturer.
- Check for fuel leaks.
- Refuel only at safe and approved filling stations such as marina fuel docks or automotive fuel stations. Approved venues have safeguards in place to lessen the likelihood of static discharge.
- Read and follow all warnings on the pump or in the vicinity of the pump.
- Maintain contact between the fuel nozzle and the fill pipe at all times, before and during refueling, to prevent an electrostatic spark.
- Be aware of the fuel tank vent to avoid splash-back and fumes during refueling.

## Section 9

- Never reenter your vehicle while refueling on land and towing your boat. Getting into and out of your vehicle might build up a static charge that could ignite the fumes at the fill pipe.
- If a fire occurs, do not panic, and do not remove the nozzle from the gas tank.
- Evacuate all passengers from the vehicle and refueling area, and immediately alert station attendants so they can use the emergency shutoff and fire extinguisher.
- If you are unable to pump fuel at a reasonable speed, check the fuel tank vent for restrictions.

After refueling, observe the following:

The first time you fill your boat's fuel tank(s) and after each refueling, check the entire fuel system for leaks and/or damaged parts. Leaks and/or damaged parts must be repaired and the area ventilated to remove explosive fumes.

- Close the fill cap(s) securely.
- Wipe up any spilled fuel completely. Dispose of the rags properly.
- Check for fuel vapors before starting the engine.
- Operate the bilge blower before the engine is started, for a minimum of four minutes.

## GETTING UNDER WAY

The following basic boat maneuvering and operation principles do not cover all conditions or situations you may encounter during operation. It is important for you and anyone else operating the boat to have certified instruction from local boating authorities.

Always advise all passengers on-board of your steering, stopping and accelerating intentions to avoid personal injury or even death.

Make sure all passengers are properly seated and not riding on the bow, gunwale or rear platform while under way. Use caution when riding in the bow. Move to the aft passenger seats during rough water operation.

## Starting

Secure the boat to the dock before starting the engine. See *Section 8 - Controls, Features and Options* for operation and location information.

1. Open the seacock in the engine compartment by moving the lever so it is parallel to the valve body.
2. Rotate Battery Switch to the ON position
3. Attach the hook of the Emergency Kill Switch Lanyard to your life jacket or belt loop. Attach the other end of the lanyard to the Emergency Kill Switch on the Power Switch panel.
4. Insert key if used and turn the Power Switch to the ON position.

5. Check that the Throttle/Shift control lever is in the NEUTRAL position.
6. Press BLOWER button to switch blower ON. Allow blower to run for at least 4 minutes or 5 minutes after fueling



## WARNING

### EXPLOSION HAZARD



**Gasoline vapors can explode. Before starting the engine, operate the blower for at least 4 minutes and check the engine compartment for gasoline leaks and vapors. Do not start engine if you smell fuel. Always run the blower below cruising speed.**

7. After 4 - 5 minutes of blower operation, press IGNITION button to turn on the side-by-side screen.
8. Check that all passengers are properly seated and are familiar with the location and operation of safety equipment.
9. Press and hold the START button until engine starts then release button. Allow engine to warm-up as noted in the Engine Operator's Manual.

## Stopping

A boat does not have brakes. Controlling your boat to a stop and while stopped are important skills that must be learned. Reverse thrust is commonly used to slow and stop a boat. The continued momentum of a boat will vary according to the boat design, load and speed. You must also consider and learn to compensate for the effects of wind and current. Stopping in wind or water currents is difficult and requires skill to be able to anticipate and compensate for these effects.

- To stop or slow forward motion, always gradually return the throttle(s) to the slow IDLE position, pause and shift into NEUTRAL, then pause and shift into REVERSE. **WARNING! Always gradually return the throttle(s) to the slow IDLE position. Failure to do so can cause loss of boat control, personal injury or death, and engine or drive system damage.**
- If the boat has been driven for a long period of time at high speed, allow the engine a two-to three-minute cool-down period at low idle in NEUTRAL.
- Turn the ignition key to the OFF position. *NOTICE: Never pull the lanyard from the engine emergency stop switch for normal shutdown. Doing so may impair your ability to restart the engine quickly.*
- Avoid collisions; at high speeds your boat will require more time and distance to stop or slow.

### Steering

Steering a boat is very different from steering an automobile. Steering and maneuvering a boat is far more difficult and requires time and practice to master.

When steering a boat, it is important to understand the causes and effects of turning. Since both thrust and steering are at the stern of the boat, the stern will push away from the direction the steering wheel (helm) is turned. The boat seems to skid across the water while turning, which feels very different from an automobile making a turn.

Steering in reverse has its own challenges. You should practice forward and reverse steering to gain comfort and to feel in control of your boat in any steering situation. All boats pull to starboard when in reverse. Turning the rudder hard to port will not always cause the boat to turn to port. Forward thrust may be required with the rudder turned hard starboard to get the stern moving to port and then shift into reverse to turn to port.

You should also be prepared for wind and current while steering your boat. Steering in wind or water currents is difficult and requires skill to be able to anticipate and compensate for these effects.

Rotational thrust of the propeller is an aspect most propeller-driven boats share and needs to be compensated for at slow speeds. During rotational thrust, torque is transmitted to the helm and may cause the boat to drift either port or starboard when moving forward at a slow speed. Rotational thrust usually goes unnoticed at high speeds. While moving forward at a slow speed, constant helm corrections may be necessary to maintain a straight course.

All rudders are designed to help reduce steering effort by pulling starboard (right-hand pull) at all speeds.



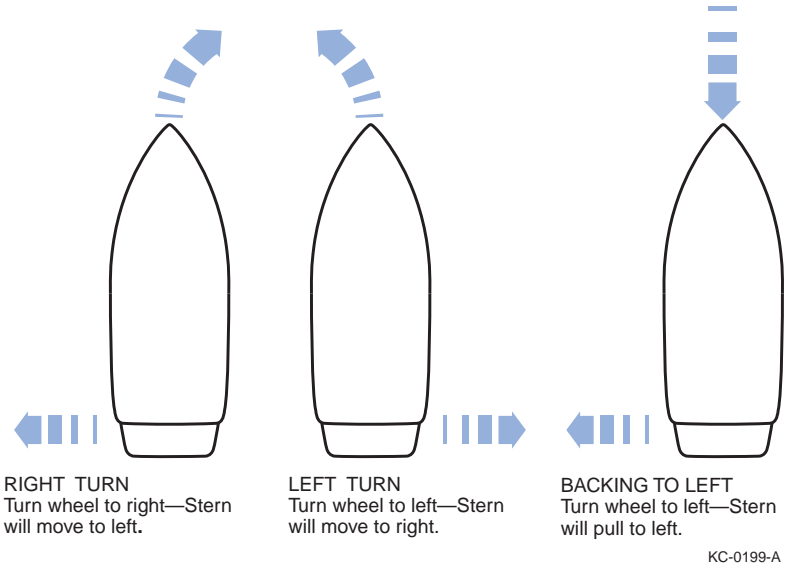

**Figure 9-4**

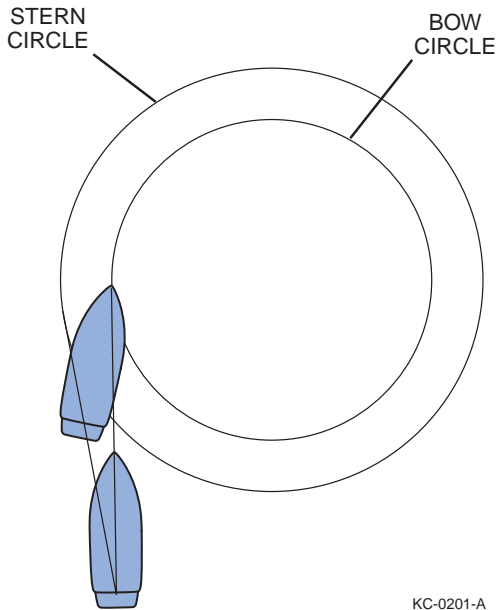

**Figure 9-5**

## Shifting

The following information is a basic guideline only and may not apply to your specific shift control. See the *Engine Operator's Manual* or control manufacturer's information for the shift control operation, adjustment and maintenance.

- Most throttle and shift controls have a neutral detent locking lever that must be released before shifting from NEUTRAL.
- Always pause in NEUTRAL before shifting from FORWARD to REVERSE, or REVERSE to FORWARD. Most throttle and shift controls have a detent position for NEUTRAL, FORWARD and REVERSE engagement positions. These detent positions are important; when shifting into and out of gear, always pause in these positions.
- Never shift into REVERSE while the boat is in FORWARD gear when traveling at a high speed.
- Always keep the shift control clean and clear of obstructions.

## Accelerating and Running Under Way

You must thoroughly understand your boat's equipment and controls in order to drive and control your boat in a forward direction at all speeds and in all conditions. Learning to drive and control your boat can be challenging; take this matter seriously and spend plenty of time practicing. **WARNING! When accelerating the boat in the forward direction, the bow can rise and restrict visibility.**

The phrase "on plane" is commonly used when referring to the running angle of a boat in forward motion. When a boat is "on plane" its hull is usually running level or almost level with the water's surface, which is considered level. The level "plane" of the water's surface is the most efficient angle to run in. This basically means that the boat is running on top of the water and not plowing through it.

Factors to consider when accelerating a boat forward and running at the most efficient planing angle are:

- Boat design
- Hull type and condition
- Boat load and distribution of weight
- Engine capability and condition
- Propeller type, size and condition
- Power trim equipment and condition (if equipped)

Because all boats are different and vary in design, purpose and load, planing angles and characteristics will vary among all boats. Seek qualified assistance to help you become familiar with your boat's characteristics.

The following guidelines provide a basic understanding of forward acceleration and operating on plane while under way:

- Always look in front of and around you before proceeding. Avoid collisions before accelerating; be aware and stay clear of people and obstacles in the water.
- Always advise all passengers on-board of your intention to accelerate and get under way.
- Stow and secure all loose gear.
- Make sure the engine emergency stop switch lanyard is connected to your person.
- If equipped, adjust the boat's trim equipment.
- Shift from NEUTRAL into FORWARD detent idle position.
- Adjust steering to the direction of travel.
- Using a controlled and constant motion, move the throttle control forward.  
**WARNING! When accelerating forward, the bow can rise and restrict visibility. Never remove your hand from the helm.**
- As the boat begins to move, the bow will rise and the boat will tend to plow through the water. As acceleration increases, the boat should begin to plane or level out within a few seconds. If the boat will not plane to a near-level position, slowly reduce the throttle back to the FORWARD detent idle position. Recheck your load and trim equipment position to determine the cause.
- Once the boat is on plane, the steering torque should be reduced; however, never remove your hands from the helm while under way. While running at a planed position, you will notice greater throttle response and steering control as you continue to accelerate or achieve the most comfortable and safe speed for the conditions. If equipped, you can achieve better performance, control and running efficiency using the boat's trim equipment,
- Be aware of the wake you create and anticipate the effect it will have on others. During acceleration, deceleration and at speeds other than on plane, a heavy wake is usually created. You are responsible for your boat's wake and any damage or injury it causes.
- Obey no-wake areas and speed-controlled areas.
- Stay clear of or at a safe distance from other boats.
- Avoid collisions; at high speeds your boat will require more time and distance to stop or slow.

## Checks During and After Operation

- Check gauges frequently for signs of abnormal conditions.
- Check that controls operate smoothly.
- Check for excessive vibration.

## Docking

Practice leaving and approaching the dock to become familiar with the procedures.

### Helpful guidelines when departing from the dock:

- Make sure you have sufficient space to maneuver your boat away from the dock, other boats and any other obstacles that may hinder your departure.
- Always allow sufficient clearance to the stern for the engine to clear any obstructions.
- Be aware of other boat traffic, wind and water conditions before departing.
- Make sure the engine is started and you have boat movement under control before casting off any mooring lines.
- Always proceed slowly when departing from a dock.

### Helpful guidelines when docking:

- Make sure you have sufficient space to maneuver your boat around the dock, other boats and any other obstacles that may hinder your approach.
- Be aware of other boat traffic, wind and water conditions on your approach.
- Always approach from a direction against the wind or current.
- When possible, approach slowly from a 45-degree angle and then steer parallel to the dock.
- Have fenders, mooring lines and assistance ready. **WARNING! Never use your hand, arm or any other part of your body to attempt to keep your boat from hitting the dock. The boat could push against the dock, causing severe injury.**
- If possible, throw a mooring line to a person on the dock and have that person secure the bow. With the bow secure, swing the stern in with the engine or pull it in using a boat hook or the stern line.
- Tie off the bow and then the stern.

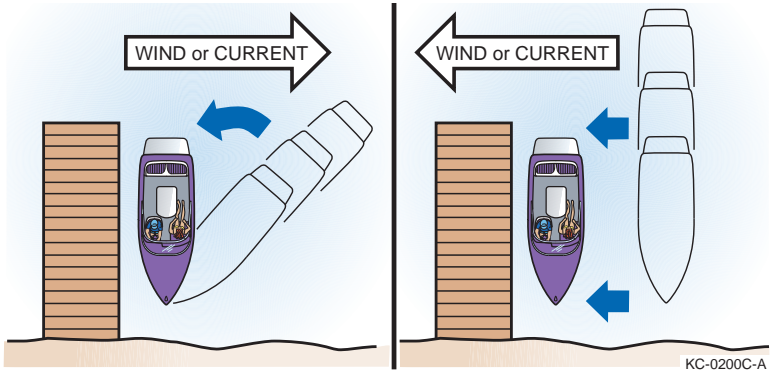

**Figure 9-6**

## Mooring

**NOTICE:** It is not recommended to leave your boat in the water for extended periods of time. Extended mooring may cause hull surfaces to discolor and/or blister. Damage caused from this type of exposure is not covered under the Centurion Boats warranty. If extended mooring is necessary, consider using a high quality bottom paint for additional protection.

Because mooring configurations vary, consult with other experienced boaters or qualified boating authorities for recommendations on properly mooring your boat. Always moor your boat securely to prevent personal injury or property damage.

### Helpful guidelines when mooring:

- Each mooring line must be of the appropriate strength, material and type to safely secure your boat when moored.
- Each mooring line must be longer than the length of your boat.
- Use bow and stern mooring lines, as well as spring lines, for additional security.
- Use fenders to protect your boat from damage.
- When possible, tie up with the bow facing into the wind or current.
- Never attach a mooring line to a point or part of your boat that is not designed to withstand the stress and the weight of the boat.
- Only use the bow eye, stern eyes and other cleats or attachment points that have been approved for mooring.
- If you plan on mooring your boat for a long period of time, use chafing protectors on lines to protect the boat's finish.
- Leave some slack in the lines to allow for wave movement or tidal action if applicable.

## Anchors and Anchoring

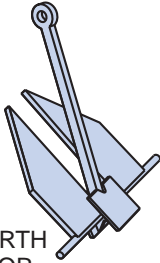

DANFORTH  
ANCHOR

KC-0042-A

Anchors are available for various applications and come in many sizes, types and shapes. Boat weight and size are primary factors in choosing an anchor. When selecting an anchor, consult other qualified boaters or local marine authorities.

Anchor line (rode) is constructed from various materials and is available in many diameters and types. Consult with your local marine supply store for a recommendation on appropriate lines for your boat anchor and application. For most applications, anchor line length should be at least six to seven times longer than the depth of the water in which you are anchoring. Always have plenty of additional anchor line on-board. **WARNING! ALWAYS anchor from the bow; NEVER anchor from the stern. A small amount of current will make a boat unsteady. A strong current can pull a boat anchored by the stern under the water and keep it there.**

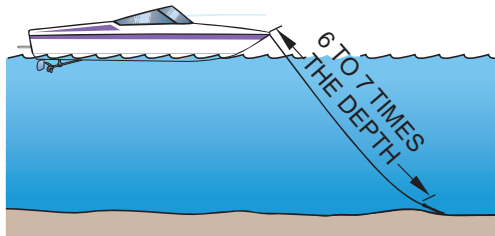

KC-0260C-A

**Figure 9-7**

### Helpful guidelines when anchoring:

- Make sure the anchor line is tied to the anchor. Tie the other end of the line to the forward cleat or bow eye.
- Head your boat into the wind or current over the spot where you want to lower the anchor.
- Stop your boat before lowering the anchor.
- Slowly lower the anchor until it hits bottom.

- Allow the boat to back away, keeping tension on the line.
- Release at least six to seven times as much line as the depth of the water.
- Secure the anchor line to the bow cleat or eye.
- Firmly pull on the line to make sure the anchor is holding.
- Occasionally check your position against the shoreline. If the anchor is dragging and the boat is drifting, reset the anchor.

## **Helpful guidelines when weighing (pulling in) the anchor:**

- Start the engine(s).
- If necessary, move forward until enough tension is off the anchor line to allow for retrieval of the anchor. Avoid running over the anchor line; retrieve the line as you approach the anchor.
- Once the anchor line is straight up and down, lift the anchor from the bottom.
- If the anchor is stuck, attach the anchor line to the bow cleat so that it is tight. The up-and-down motion of the bow from wave action may loosen the anchor from the bottom. If the anchor remains stuck, let out a few more feet of line and attach it to the bow cleat. While keeping tension on the line, slowly maneuver your boat around the anchor to help loosen it. Avoid running over the anchor line.
- Always stow and secure the anchor and line before departing.

## Lines and Knots

Mooring, anchor and other nautical lines are constructed from many different types of materials, and are available in many diameters and styles. Consult with your local marine supply store for a recommendation of appropriate lines for your boat and application. Commonly used mooring lines are constructed of a high-quality synthetic material in a double-braided configuration and usually have eye splices on at least one end.

Learn and become familiar with tying and using knots. Knowing how to use knots and lines properly can prevent personal injury and property damage.

Practice tying lines to docks, cleats and anchors, and connecting two lines together. Consult other qualified boaters or local marine authorities, or visit your local bookstore, library or the Internet for information on the proper use of nautical lines and knots. The following illustrations represent a few examples of securing mooring lines.

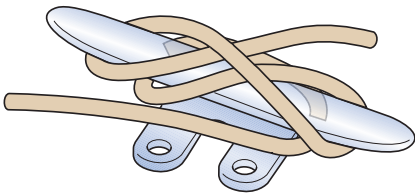

**Cleating an open line**

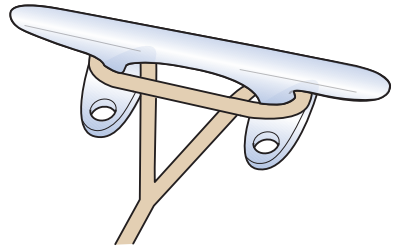

**Cleating an eye-spliced line**

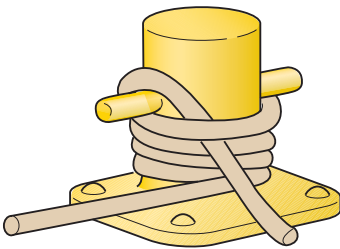

**Securing to a dock bit**

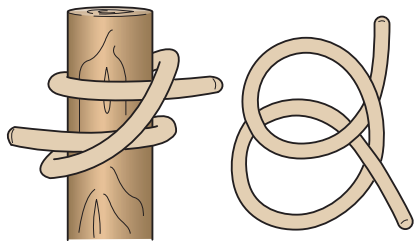

**Securing to a piling  
using a clove hitch**

KC-0248C-A

**Figure 9-8**



# CENTURION BOATS

## Section 10

# TRAILERING AND LAUNCHING

Before using your trailer, see *Safety* on page 3-1.

## LEGAL CONSIDERATIONS

The following information is intended as a basic guideline only. See the *Trailer Operator's Manual* for information on operation, adjustments and maintenance.

Before you use your trailer, contact your state's Department of Motor Vehicles (and that of other states through which you may be traveling) for information on trailering regulations. Trailer regulations vary widely from state to state, and it is your responsibility to be in compliance with all regulations when trailering your boat.

Regulations include, but are not limited to, trailer registration, licensing, width, height, length, lights, safety chains, tie-downs, hitch type, weight capacity, brakes, spare wheels, vehicle mirrors and gross vehicle weight.

## TRAILER TYPE

Trailers are designed for many applications and can vary in style. To prevent damage to your boat and/or personal injury, always use the appropriate trailer for your boat. Contact your dealer for more information.

## TRAILER CLASSIFICATION

Trailers are separated into four classes based on the Gross Vehicle Weight Rating (GVWR):

Trailer Class	GVWR
Class One	under 2000 lb (907 kg)
Class Two	over 2000 lb (907 kg) and under 3500 lb (1588 kg)
Class Three	over 3500 lb (1588 kg) and under 5000 lb (2268 kg)
Class Four	over 5000 lb (2268 kg)

## TRAILER GROSS VEHICLE WEIGHT RATING

All trailers must display a Gross Vehicle Weight Rating (GVWR) decal, which shows the load-carrying capacity plus the weight of the trailer. The total weight of your boat (fully loaded with fuel, batteries, water, etc.), engine, gear and trailer must never exceed the GVWR.

## VEHICLE TOWING HITCH

The towing vehicle must be able to safely pull the full trailer and boat load. The vehicle must have a towing hitch that is capable of safely handling the trailering load and tongue weight of the trailer.

Hitches are designed for many applications and can vary in style. Use professional assistance when selecting the correct hitch and hitch ball for your towing application. **WARNING! A vehicle hitch that is underrated or improperly installed can lead to loss of control of the trailer and/or vehicle, causing serious personal injury or even death.**

Hitches are divided into classes that specify the trailer's gross trailer weight and maximum tongue weight for each class. **WARNING! Never use a hitch that is not rated to pull the maximum weight of your trailering load or that is not rated for the maximum tongue weight that your trailering load applies.**

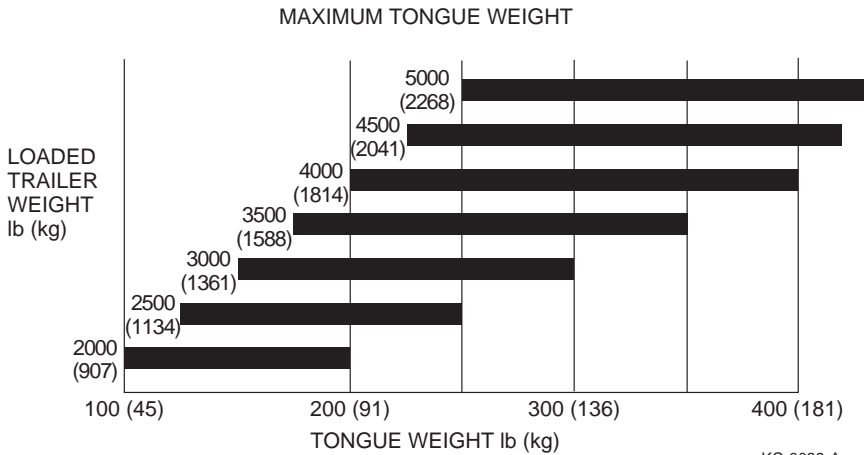

Figure 10-1

## HITCH BALL AND TRAILER COUPLER

Most boat trailers have a coupler that connects to a hitch ball attached to the towing vehicle's hitch. The trailer hitch coupler must always match the size of the hitch ball. The correct hitch ball diameter for the coupler is usually marked on the trailer coupler. **WARNING! Never use a hitch ball size or rating that does not match the trailer coupler specifications.**

Trailer hitch balls are sized and rated for use based on the trailer GVWR:

Trailer Class	GVWR	Hitch Ball Diameter Size
Class One	under 2000 lb (907 kg)	1-7/8 in. diameter size
Class Two	over 2000 lb (907 kg) and under 3500 lb (1588 kg)	2 in. diameter size
Class Three	over 3500 lb (1588 kg) and under 5000 lb (2268 kg)	2 in. diameter size
Class Four	over 5000 lb (2268 kg)	2-5/16 in. diameter size

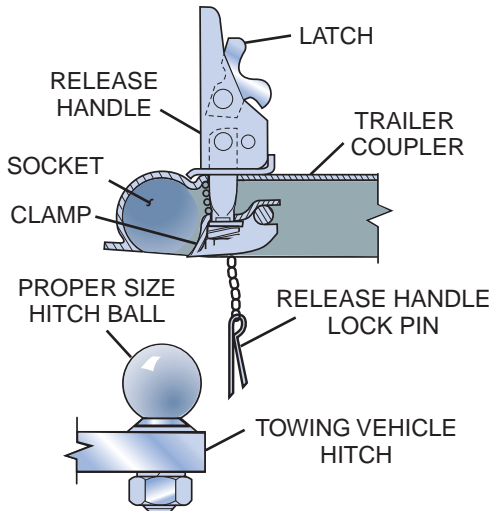

KC-0043C-A

Figure 10-2

## SAFETY CHAINS

Your boat trailer's safety chains prevent the trailer from completely detaching from the towing vehicle when under way. Connect the chains to the vehicle's hitch or frame and crisscross the chains under the trailer tongue to prevent the tongue from dropping to the road if the trailer separates from the hitch ball. Rig the chains as tight as possible with enough slack to permit full-free turning. Safety chains must be rated at the same or greater weight capacity as the trailer's GVWR.

Never allow the chains to drag on the ground when trailering.

Attach the chains properly and securely between the towing vehicle and trailer before trailering.

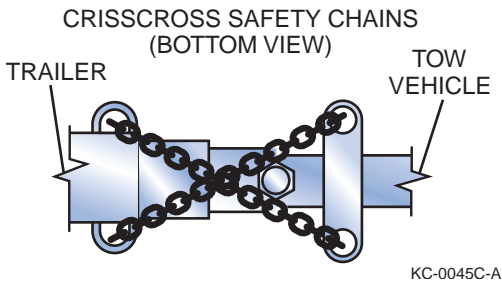

Figure 10-3

## TOWING VEHICLE

The towing vehicle must be able to safely pull the full trailer and boat load. Never pull a trailer load that exceeds the vehicle's towing capacity; you risk losing control of the trailer and/or vehicle. Before trailering, always check your *Vehicle Operator's Manual* for maximum towing/trailer load specifications and maximum gross vehicle weight specifications that include the fully loaded trailer.

## TRAILER BRAKES

In some states, any trailer with a GVWR of 1500 lb (680 kg) or more is required to have trailer brakes. Check with your state and local authorities for more information.

The three basic types of trailer brakes are electric, hydraulic surge and air-actuated. If your trailer is equipped with brakes, see the *Trailer Operator's Manual* for more information on operation, adjustments and maintenance.

### Typical

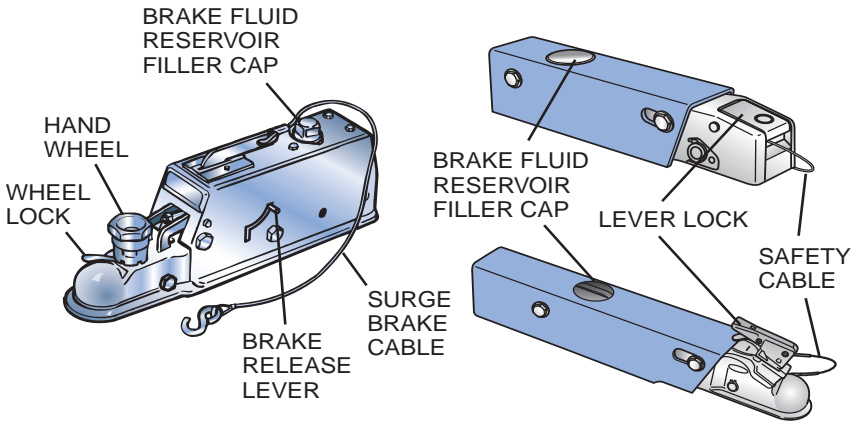

CNTRN-0057-A

Figure 10-4

## 5-Pin Wiring Connector

Some trailers equipped with surge brakes may utilize a 5-pin wiring connector. These trailers use an electric solenoid valve that allows brake fluid to bypass back to the reservoir while in REVERSE. The solenoid is usually connected to the reverse lights on the tow vehicle to ensure the brakes only bypass in REVERSE. The fifth pin is for deactivating the brakes when backing up, and is required to be connected to the vehicle's power when backing up. In some instances, the 5-pin connector can be connected to a 4-pin connector for normal operation of the lights.

# TRAILERING GUIDELINES

Follow these guidelines when trailering:

- Maintain a safe speed as regulated by the trailering laws of the state where you are traveling.
- Check the trailer and vehicle brakes for proper operation and fluid level prior to departure.
- Check the trailer for damage prior to departure.
- Once the trailer is secured to the vehicle hitch, stow the trailer jack or lift (if equipped) so that it will not hit the ground.
- Check the trailer and vehicle tires for proper inflation. Under-inflated tires heat up rapidly and may cause tire damage or failure.
- Check trailer wheel bearings and lug nuts before each trip.
- Fasten the bow of the boat to the trailer with the bow winch line connected to the bow eye and bow safety chains (if equipped).
- If travel conditions require, use an additional tie-down strap across the rear of the boat from side to side to further secure the stern.
- Secure the stern of your boat to the trailer from the stern eyes.
- Check all strapping material for wear.
- Make sure trailer and vehicle running, brake and signal lights are in good working condition.
- Drive with the vehicle and trailer running lights on.
- Too much or too little tongue weight makes steering difficult and causes the tow vehicle to sway. Approximately 5% to 10% of boat and trailer weight should be placed on the tongue.
- Remove any covers or bimini tops (if equipped) that are not designed to stay on boats at highway speeds.
- Carry a spare tire and wheel for both your trailer and your towing vehicle, along with tools to change them.
- See the *Engine Operator's Manual* for engine-related trailering information. Continuous road shocks may fatigue the boat steering system.
- On extended trips, carry spare wheel bearings, seals and races.
- While traveling, check the wheel hubs every time you stop. If the hub feels abnormally hot, inspect the bearing before continuing your trip.
- Carry a fire extinguisher in the vehicle.
- Drive slowly over railroad tracks or rough roads.
- Turn carefully while towing a trailer; additional space and distance are needed.
- If you trailer your boat from lake to lake, you may unknowingly introduce a foreign aquatic species from one lake to the next. Thoroughly clean the boat below the waterline, remove all weeds and algae, and drain the bilge and livewells before launching the boat in a new body of water.
- Make sure the hitch ball and trailer coupler are the same size and bolts and nuts are tightly secured.

- The coupler must be completely over the ball and the latching mechanism locked down.
- Make sure the lights on the trailer function properly.
- The safety chains must be attached crisscrossing under the coupler to the frame of the tow vehicle. If the ball was to break, the trailer would follow in a straight line and prevent the coupler from dragging on the road. Make sure the trailer emergency brake cable or chain is also installed to the tow vehicle frame.
- Make sure the tow vehicle has side view mirrors that are large enough to provide an unobstructed rear view on both sides of the vehicle.

Note: Make sure your towing vehicle and trailer are in compliance with all state and local laws. Contact your state motor vehicle bureau for laws governing the towing of trailers.

## Backing Up

If you have never towed a trailer before, take time to practice and become comfortable with backing up your boat and trailer. Situations can arise in traffic, or when launching, that will require you to be able to back up your trailer safely.

Follow these guidelines when backing a trailer:

- Back slowly and make small steering adjustments.
- Turn the car wheels in the direction opposite where you want the trailer to go.
- After the trailer begins moving, turn the car to follow it.
- Have a second person assist you with audible and hand signals.

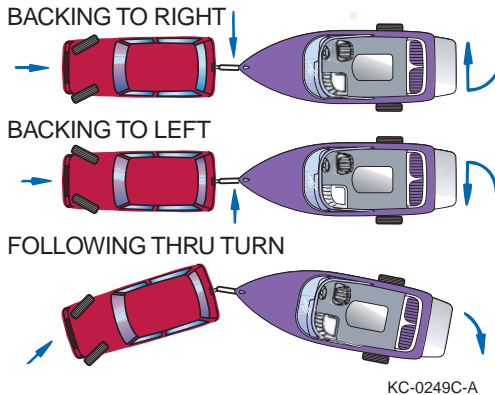

Figure 10-5

## LAUNCHING

Before launching, inspect the launch ramp for any problems that may hinder launching or make launching unsafe. Ramps can be slick and dangerous to drive or walk on, and may have unseen drop-offs beneath the water that would pose a safety hazard. Always be aware of water conditions and the effects of the wind when launching.

Before launching your boat, inspect the boat and trailer for damage. Do not launch if you detect damage or find that the engine or propeller is not in good operating condition. Have any repairs made before launching.

Use courtesy when preparing the boat for launching by doing so away from the ramp on level ground before proceeding to the launch ramp.

When launching your boat on the trailer, have two or more people assist you. Since all launches are different, the following procedures are intended as guidelines only:

- Verify that your vehicle's brakes, including the parking brake, are in proper working order.
- Make sure the trailer is securely fastened to the vehicle.
- Remove the boat cover, if equipped.
- Check that the bilge drain plug is in place and all other plugs that allow water to leak into the boat are in place.
- Remove all tie-downs from the boat.
- Attach the bow and stern docking lines.
- Attach boat fenders if necessary.
- Disconnect the trailer lights from the car if applicable, some trailers using surge brakes require the 5-pin harness connected to the vehicle to allow the trailer to be backed-up.
- Make sure the bow winch and strap are securely locked and fastened.
- Make sure all required documentation and safety equipment are on-board.
- Verify that batteries are fully charged and in good condition.
- Check fuel level; add fuel if necessary.
- Always launch with the help of another person.
- Make sure there is no one on the ramp behind the boat.
- Keep the trailer/vehicle combination as straight as possible and at 90 degrees to the shoreline.
- Back slowly down the ramp until the transom of the boat is a few inches under water; then stop the vehicle.
- Stop the vehicle and shift into PARK (automatic transmission) or REVERSE (manual transmission). Apply the brakes and/or parking brake. If possible, use wheel blocks.
- Position the mooring lines within reach of the dock.



- Disconnect the bow winch strap and safety chains, (if equipped), from the bow eye.
- Manually back the boat clear of and off the trailer into the water and secure to the dock using mooring lines.
- Remove any wheel blocks and release the vehicle brakes. Pull the trailer slowly out of the water, and secure and park in a designated area.
- Board the boat.
- Run the bilge blowers as required, if equipped.
- See the *Engine Operator's Manual* for starting procedures.
- Remove dock lines from the dock and proceed slowly away from the dock.

## LOADING GUIDELINES

Follow these guidelines while loading the boat onto the trailer:

- When loading your boat on the trailer, have two or more people assist you.
- Stop, turn off the boat and secure it to the dock with dock lines at a position clear from where the trailer will be in the water.
- Verify that your vehicle's brakes, including the parking brake, are in proper working order.
- Disconnect the trailer lights from the car, if applicable. Some trailers using surge brakes require the 5-pin harness connected to the vehicle to allow the trailer to be backed up.
- Make sure the trailer is securely fastened to the vehicle.
- Back the trailer slowly down the ramp until it is positioned so that the boat can be loaded.
- Stop the vehicle and shift into PARK (automatic transmission) or REVERSE (manual transmission). Apply the brakes and/or parking brake. If possible, use wheel blocks.
- Position the mooring lines within reach of the dock.
- Manually position the boat onto the trailer using mooring lines. Make sure the boat is centered on the supports of the trailer.
- Position the bow eye into the bow stop and connect and secure the bow winch strap and safety chains (if equipped) to the bow eye.
- Secure the mooring lines inside the boat.
- Remove any wheel blocks and release the vehicle brakes. Slowly pull the trailer and boat up the ramp.
- Secure the transom to the trailer.
- Prepare for trailering as necessary.

**This Page Intentionally Left Blank**

# CENTURION BOATS

## Section 11

### GENERAL CARE AND MAINTENANCE

Your boat may feature a variety of specialized systems and components. The following basic and typical information may not apply to your specific application. This section may not cover all systems or components on your boat. See the *Engine Operator's Manual* or the equipment manufacturer's information for maintenance procedures.

Maintenance procedures may require special knowledge and equipment. Always consult your local marine dealer or certified marine technician for assistance in performing service, maintenance or modifications to your boat.

Neglect of maintenance and unauthorized service work is not recommended and may void your warranty. Refer to the Engine and Equipment Manufacturer's maintenance schedules and requirements, and keep a detailed log of the procedures and dates completed. Always consult your local marine dealer for assistance with periodic maintenance.

## HULL DISCOLORATION

### WARNING

#### HULL DAMAGE



If you leave the boat moored in the water for long periods of time, a condition may develop where you may experience signs of discoloration and/or “blistering” of the hull below the waterline. This is a normal condition for all fiberglass boats and does not indicate a problem with materials or workmanship. This condition is not covered under warranty.

See Section 2 - Warranty for more information. If it is necessary for your boat to stay in the water, you should consider applying high-quality bottom paint for additional protection. Talk to other boaters in the area or see your dealer for recommendations.

## 20-HOUR INSPECTION

A boat inspection is required between the first 15 to 20 hours of boat operation. The following maintenance must be performed at or before the 20-hour inspection by an authorized Centurion dealer. See the *Engine Operator's Manual*, *V-Drive Operator's Manual* or specific equipment operator's manuals for additional information.

- Check prop shaft alignment.
- Tighten all engine mounting bolts.
- Tighten all steering, throttle and shift system fasteners.
- Perform all recommended engine maintenance procedures.
- Inspect fuel system for any damage or leaks.
- Inspect ski pylon for damage and proper attachment.
- Check bilge pump for proper operation in manual and automatic modes.
- Inspect all Fasteners for tightness.
- Check engine and V-drive fluid levels.

### NOTICE

*Centurion Boats assume no responsibility for the cost related to the 20-hour inspection. This is the owner's responsibility and is required to maintain your factory warranty.*

## 25-HOUR ENGINE INSPECTION

After the first 25 hours of operation, it is recommended that the engine be given an inspection. Your boat dealer or PCM Premier servicing dealer should be contacted to perform the necessary checks and adjustments to ensure the proper engine performance. The following maintenance is from PCM Engine Manual that is included within each owner's package and should be performed:

- Change the engine oil and filter.
- Replace the primary fuel pre-filter.
- Check the engine alignment.
- Inspect the accessory drive belt(s) and check the tension.
- Check the fluid levels.
- Check the throttle and shift cable adjustments and check for freedom of movement.
- Cooling System - Inspect all hoses for leaks, damage and deterioration. Check all the hose clamps for adequate tightness.
- Exhaust System - Inspect the entire exhaust system for leaks, damage and deterioration. Check all the hose clamps for adequate tightness.
- Battery. Check the electrolyte level and specific gravity. Inspect the case for damage. Check the battery cables and connections.

- Engine Assembly - Check for loose, missing or damaged parts. Pay close attention to engine mounts, starter and alternator mounting fasteners.

## NOTICE

*PCM Engines assume no responsibility for the cost related to the 25-hour inspection. This is the owner's responsibility.*

## PERIODIC MAINTENANCE

It is recommended that you read and understand the periodic maintenance procedures outlined in your *Engine Operator's Manual* and *V-Drive Operator's Manual*.

Perform the following inspections semiannually or every 100 hours.

- Perform all related periodic maintenance procedures outlined in your *Engine Operator's Manual* and *V-Drive Operator's Manual*.
- Inspect all hardware for pitting, corrosion or wear, and repair or replace as necessary.
- Clean the battery terminals and inspect the batteries and hold-downs for damage. Repair or replace as necessary.
- Check the propeller shaft coupling alignment. Contact your dealer for service recommendations.
- Check the propeller shaft seal for leakage. Repair or replace as necessary.
- Inspect and lubricate the steering system.

## ENGINE

The manufacturer of your boat's engine(s) will provide a separate maintenance schedule. See the *Engine Operator's Manual* for specific information on maintenance procedures.

## FUEL SYSTEM

A fuel tank vent is usually located in the filler deck plate or near the filler. Periodically check that the fuel fill and vent lines are free of obstructions and kinks.

Check and/or replace the fuel filter periodically or clean as needed. Check fuel lines, vent hoses and drain hoses frequently for leaks. Replace any worn or cracked hoses.

Tightening a fitting or clamp may correct a fuel leak. If the leak continues, however, replace the line, fitting or hose immediately to prevent a buildup of fluids or gases.

Use fuel system parts certified for marine use only. Never use automotive parts in marine applications.

## V-DRIVE

See the *PCM Engine Owner's Manual* for specific information on maintenance procedures.

## STEERING SYSTEM

The steering system is the primary link for boat control and must be inspected and maintained regularly. The following basic inspection and maintenance procedures may not apply to your steering system. For additional information contact your dealer. **WARNING! LOSS OF CONTROL AND UNSAFE BOAT HAZARD.**

***Improper maintenance of the steering system is hazardous and can cause death or serious injury from sudden loss of control. Ensure that all steering hardware, cables and grease fittings are regularly inspected and maintained. If any steering problems are noticed, DO NOT operate the boat and contact your dealer immediately for service assistance.***

- The rack-and-pinion helm gear box is typically a sealed and lubricated unit, which requires no additional lubrication. Contact your dealer for specific information on your helm unit.
- The steering cable requires periodic maintenance and lubrication. Contact your dealer for specific service information.

The rudder arm is connected to the rudder shaft. The rudder shaft is lubricated by the rudder stuffing box. The rudder stuffing box may be sealed or incorporate a grease fitting to allow lubrication during maintenance. Contact your dealer for specific service information.

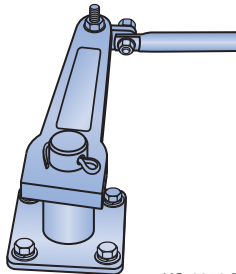

KC-0250-B

**Figure 11-1**

The rudder should be checked frequently for damage and tightness. If the rudder is damaged or requires service, contact your dealer for service.

## ELECTRICAL SYSTEM

Before performing any work on the electrical system or battery, see *Safety on page 3-1 and 3-2.*

### Battery

Always turn off the battery switch (if equipped) or disconnect the negative battery cable before servicing the electrical system.

When you install a battery:

- Always use correct polarity when you connect the battery cables to the battery.
- Make sure the battery terminals are clean.
- Make sure the cable connections are tight.
- Always shut down the engine before removing or attaching battery cables and never run the engine with the battery cables disconnected.
- Always remove the negative (-) cable first. Always attach the negative (-) cable last.

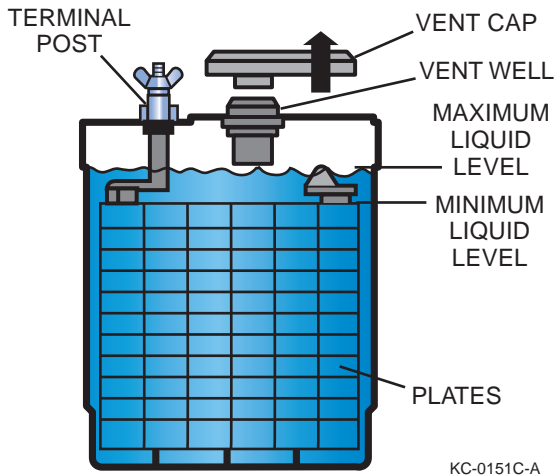

**Figure 11-2**

Check the battery frequently for signs of corrosion. If corrosion is evident, clean the terminal posts with a baking soda and water solution and a wire brush. Disconnect the battery terminals before cleaning.

Check the fluid levels in the cells. **NOTICE:** *Some batteries are sealed and cannot be filled.* A level of approximately 1/4 to 1/2 in. (6 to 13 mm) above the plates is sufficient. If needed, fill with distilled water; do not overfill. **WARNING! Lead-acid battery fluid can cause severe burns.**

During extended periods of non-use, batteries will self-discharge and should be recharged. Before recharging, disconnect the battery terminals and remove the battery from your boat. Recharge the battery according to the directions enclosed with your battery and battery charger. When installing the battery in your boat, make sure the battery is secured in the battery box, the terminals are tight and all protective covers are in place. **WARNING! Hydrogen gases produced by a lead-acid battery while it is charging, or the engine is running, can cause an explosion and/or a fire.**

### Circuit Breakers and Fuses

Never exceed the recommended fuse sizes or bypass a fuse in a circuit. Always install the proper (type and rating) fuses whenever replacing or changing fuses. Continuous fuse/breaker failures indicate a severe problem and require immediate attention. **WARNING! Installing an incorrect fuse or breaker can cause a fire.**

Some applications use circuit breaker switches to provide individual circuit protection with the ability to manually reset the breaker switch.

To reset a tripped circuit breaker, position the breaker switch to OFF. Identify and correct any problems with the circuit and unplug all loads connected to it. Wait a minimum of one minute for the breaker switch to cool and then push the breaker switch to ON. Turn the breaker switch to OFF immediately if it trips, and consult qualified personnel.

To replace a fuse, locate the fuse block and the failed fuse. Carefully remove the fuse without touching other fuses or wires. When possible, use a fuse removal/installation tool. **WARNING! Never reset a breaker that has been automatically tripped, or replace a burned out fuse, without first identifying and correcting the cause of the problem. A fire could result.** **NOTICE:** A boat's electrical system is designed to protect you from electrocution, short circuits and overloads. Have a qualified electrician perform any modifications to the system, such as adding electrical accessories. Some installed accessories, such as stereos, have an additional fuse located in-line with the positive lead. Other accessories may use in-line fuses near the battery.



## CORROSION PROTECTION

### Hardware, Fasteners and Fittings

Check all fasteners, fittings, hinges, latches, rails and cleats for corrosion and tightness. Repair or replace any items that need attention. Never use automotive replacement parts when replacing marine parts.

Periodically clean all hardware with approved marine cleaners or mild soap and water. Never use abrasive cleaners or materials; they will scratch the polish and protective coatings on the hardware and cause the hardware to corrode. Applying a coating of marine-grade wax can help maintain the original shine of the hardware and help prevent corrosion.

### Stainless Steel and Chrome Hardware

Stainless steel and chrome will normally oxidize over time, especially in marine environments. Cleaning and preventive maintenance of stainless steel and chrome hardware are crucial in maintaining appearance and functionality. If the hardware is left unattended, it can corrode, causing the hardware to appear unsightly and cause structural integrity problems.

Wash the stainless steel and chrome hardware with mild soap and water after operating your boat in corrosive environments such as salt water.

Remove rust or corrosion promptly by cleaning the hardware using a high-quality stainless steel, chrome cleaner or conditioner. Do not use any abrasive materials such as steel wool or sandpaper to clean the hardware. Do not use acids or bleach or any cleaners not intended for stainless steel or chrome, such as glass, tile or counter cleaners, as these types of cleaners can cause permanent damage. Always test a cleaner in an inconspicuous area first before applying to the complete surface.

After cleaning, protect the surface of the hardware by using a high-quality boat, automotive, stainless steel or chrome protectant or wax.

### Aluminum Hardware

Aluminum hardware should be washed periodically with soap and water to keep it clean. If the boat is used in salt water or polluted water, aluminum hardware should be washed with soap and water after each use. Salt water allowed to remain on aluminum will penetrate the metal and corrode the aluminum.

It is recommended to frequently clean and coat all aluminum hardware with a metal protectant made for aluminum to protect against pitting and corrosion caused by the harsh effects of salt water. Choose an appropriate cleaner specific to your needs, as special cleaners are available for different types of aluminum hardware such as anodized, powder-coated and polished.

## Galvanic Corrosion

Galvanic corrosion (electrolysis) is the deterioration of metals from the effects of electrolytic action. When two dissimilar metals are immersed in a conductive fluid such as salt water, an electric current is produced, much like a battery. As current flows between the two metals, the softer, or sacrificial, metal deteriorates.

If you operate in salt, polluted or brackish waters, your boat should be equipped with a transom-mounted sacrificial anode to prevent corrosion damage to other metal parts of your boat that are in contact with the water. The anodes are self-sacrificing and are slowly eroded by electrolytic action. These anodes are important and require periodic inspection for deterioration. Replace the anode when less than 50% of its original size.

Most engines are equipped with one or more anodes that require periodic inspection. See the *Engine Operator's Manual* for maintenance procedures.

Electronic cathode systems are designed to reduce the effects of electrolysis. Electronic cathode systems emit an electrical low-current charge into the water near the metal components' neutralizing electrolytic action. **NOTICE: Do not paint or coat sacrificial anodes or cathodes with any substance. Once covered, they do not provide protection from galvanic corrosion. Replace anodes if they have deteriorated 50% or more.**

## Salt Water Corrosion

Rinse your boat hull and deck with fresh water and wash immediately after using your boat in salt water. If your boat is used primarily in salt water, wax the hull monthly and apply corrosion inhibitor to all hardware. See the *Engine Operator's Manual* for the flushing procedure.

Flushing the freshwater engine cooling system is recommended when the engine has been used in salt, polluted or brackish waters. Flush the entire engine cooling system with fresh water for at least 5 minutes after use in these waters. Consult your local marine dealer for suitable flushing equipment.

## GENERAL MAINTENANCE AND CLEANING

### Marine Growth

If accelerated marine growth is a problem in your area, an antifouling bottom paint may be necessary to slow growth and prevent gelcoat damage. Before selecting a bottom paint, talk with other boaters and your local marine dealer to determine which product works best in your area. Many local variables can affect the selection of paint. Be sure to follow the paint manufacturer's directions exactly.

## Cleaning

Never allow any type of cleaning solution or cleaning material to come in contact with the water or be discharged into the water. The discharge of any type of debris or waste, including, but not limited to, food, trash, garbage, oil, fuel, liquids and human waste, is highly restricted, if not unlawful, in most waterways. Never discharge anything into the water.

Periodic cleaning is the best way to keep your boat looking new. Regular washing and waxing keep dirt, algae and water deposits from building up and deteriorating the finish. Keeping your boat in “show room” condition means greater personal satisfaction and higher resale value. Special cleaning products are available from your local marine dealer.

## Hull

*NOTICE: Do not leave your boat in the water for extended periods of time. Extended mooring may cause hull surfaces to discolor and/or blister. Damage caused from this type of exposure is not covered under the Centurion Boats warranty. If extended mooring is necessary, consider using a high-quality bottom paint for additional protection.*

When washing your boat, use a mild detergent with a warm water solution. Never use abrasive cleaners, solvents, ammonia or chlorine to clean gelcoat surfaces, as these will damage the gelcoat surface. Special cleaners are available from your local marine dealer to remove marine growth and algae from the hull.

Wax gelcoat surfaces at least twice a season. Special marine gelcoat waxes are available from your local marine dealer to prevent color fade and dirt adhesion. If the gelcoat has oxidized, chalked, dulled or faded from lack of proper maintenance, buffing may be necessary to bring back the shiny appearance. Hand buffing with #7 rubbing compound or power buffing with glazing compound #1 will quickly restore the surface; however, always seek certified assistance before attempting to restore your boat's finish.

## Upholstery

Regular washing with warm soapy water is sufficient to keep the upholstery in good condition. For additional information on cleaners and upholstery maintenance, see the Upholstery Care information in your *Owner's Information Kit*.

## Canvas Covers and Bimini Tops

Regular washing with warm soapy water is sufficient to keep the canvas and bimini top in good condition. For additional information on cleaners and maintenance, see the Sunbrella® Fabric Care and Roswell™ *Owner's Manual* information in your *Owner's Information Kit*.

## **Carpet**

Occasional vacuuming and washing with mild detergent and warm water or household carpet cleaners will keep the carpet clean. Thoroughly wash the detergent out of the carpet with clean water. Let the carpet dry in the sun to prevent any mildew or odor caused by moisture.

## **Windshield**

A clean windshield is important. Your boat is equipped with a glass windshield, which can be sufficiently cleaned with a nonabrasive glass cleaner and a soft cloth. Harsh detergents, solvents, chemicals or dry cloths used on any glass windshield can scratch the surface.

## **Bilge**

A boat's bilge area accumulates oil and greasy dirt over a period of time and should be cleaned periodically. Consult your local marine dealer for recommendations on special bilge cleaning products and procedures.

## **Bilge Pump**

Periodically check the bilge pump(s) inlet screens and hoses for obstructions and debris. Foreign materials can clog the screen and hoses or become lodged in the bilge pump impeller, which can cause the pump to malfunction. Periodically check the operation of the bilge pump and float switch, if equipped. Inspect all wiring, clamps and hoses for tightness on a regular basis.

## **Cockpit Heater**

The marine heater must be drained completely for winter storage. When winterizing the engine cooling system, the heater must be included. See the *Marine Heater Operator's Manual* for further information.

## **Trim Tab/Stinger Wake Plate**

Periodically inspect the trim tab for damage and leaks. Check the hydraulic pump (if equipped) fluid level periodically and fill with the recommended fluid.

## SAFETY EQUIPMENT

Periodically check the safety equipment for damage, general condition and operation when applicable. Always replace safety equipment that is in question or in need of repair:

- Fire extinguisher
- Life jackets
- Visual distress signaling devices
- Audible distress signaling devices
- Navigational lights
- Emergency radios or Emergency Position Indicating Radio Beacon (EPIRB)
- First aid kit

## GENERAL BOATING EQUIPMENT

Periodically check the general equipment on-board for damage, general condition and operation when applicable. Always replace equipment that is in question or in need of repair.

- Anchors and anchor lines
- Boat hook
- Dock fenders
- Foul weather gear/clothing
- Mooring lines
- Oars/paddles
- Tool kit
- Tow line

## TRAILER

Periodically check the general trailer components for damage, general condition and operation when applicable. Always replace trailer components that are in question or in need of repair.

- Lights
- Electrical connectors
- Tires (condition and pressure)
- Wheel lug nuts and studs
- Wheel valve stems
- Wheel bearings
- License plate and holder
- Rollers, bunks and hardware
- General fasteners (missing, loose or corroded)
- Safety chains or straps
- Winch, winch strap and hooks
- Trailer coupler and latch
- Frame, axle and springs
- Spare tire and wheel
- Brakes and actuator assembly

# CENTURION BOATS

## Section 12

# WINTERIZATION AND STORAGE

Your boat may be equipped with a variety of specialized systems and components. The following basic and typical information may not apply to your specific application. This section may not cover all systems or components on your boat. Consult your local marina or certified marine technician for assistance.

Winterizing or storing your boat for extended periods of non-use requires special preparation to prevent boat and system damage. Without proper preparation, if your boat is not used or is stored for extended periods of time, internal parts of the engine may become corroded from lack of lubrication. If your boat is stored in freezing temperatures, water inside the bilge, engine cooling system or boat water systems may freeze and cause damage. Be sure to keep up with all annual maintenance during winterization.

## WINTERIZATION AND STORAGE PREPARATION

The following procedures should help prevent damage to your boat:

- While the boat is still in the water, fill fuel tank(s) with fresh fuel and add the proper amount of fuel stabilizer/conditioner according to the engine manufacturer's recommendations. Operate the boat for at least 15 minutes to ensure that the treated fuel has reached the engine. *NOTICE: If you plan to store your boat for more than 3 months in either a humid environment, extreme temperatures or outdoors, "fog" the engine with a corrosion-preventing fogging oil according to the engine manufacturer's recommendations. See the Engine Operator's Manual for more information.*
- Once the boat is removed from the water, remove the bilge drain plug on the transom and the T-handle plug located under v-drive access port immediately. Store the plugs in a plastic bag and tape it to the throttle control lever for easy accessibility the next time you use your boat.
- Inspect all sacrificial corrosion protection anodes for excessive wear and replace as necessary.
- Check all thru-hull fittings and other fasteners for tightness and leakage.
- Thoroughly clean the hull, deck and interior of the boat as soon as you remove it from the water; marine growth is easier to remove when it is wet.

## Section 12

- Always allow all boat compartments to air dry for a couple of days to prevent mildew from trapped moisture. If you use shrink wrap, always allow for ventilation to prevent mildew from trapped moisture.
- Apply a coat of wax to the entire surface of the boat and rust inhibitor on all metal parts.
- Clean all traces of dirt, oil, grime and grease from the engine and bilge.
- After washing, raise the bow of the boat high to allow as much water as possible to drain while performing other storage preparations.
- Prepare the engine for storage according to the *Engine Operator's Manual*.
- Perform all scheduled maintenance for the engine and boat equipment. See the *Engine Operator's Manual* and all equipment manufacturer's information for periodic and annual maintenance procedures.
- Turn off all electrical switches and breakers.
- Remove all batteries from the boat. Clean, fully charge and store the batteries in an area outside the boat not subject to freezing temperatures. Never store batteries close to heat, sparks or open flames. Do not store batteries on cement or concrete surfaces.
- Open all water drains and seacocks, and thoroughly drain all ballast tanks (if equipped) and water lines. Manually disconnect any lines that may have residual water trapped.
- Thoroughly drain all ballast tank filters (if equipped) that may have residual water trapped.
- Clean all interior upholstery, furniture and carpet.
- The use of pest or rodent repellents may help prevent damage to your boat during storage.

### ENGINE & V-DRIVE WINTERIZATION

Proper engine winterization is dependent on the engine installed; remove only the plugs / clamps identified for your model in the PCM engine owner's manual. Engines with closed cooling contain anti-freeze coolant in the closed system and do not need to be drained; only the sea water part of the system needs draining. **If you have a closed cooling system with a cockpit heater installed, do not drain the heater as it is plumbed in the closed part of the system.**

### NOTICE

*Always refer to the PCM engine Owner's Manual for specific engine winterization requirements.*

### STORING ON A CRADLE OR BLOCKS

- When storing a boat on support other than the proper trailer, make sure the hull is supported properly to prevent damage. Most cradles are custom-built to support the boat's hull.



- The cradle or blocks must be on a hard, level surface capable of supporting the combined weight of the cradle and the boat.
- When using blocks with jack stands, always use jack stands that are rated for more than the required load, making sure they are securely positioned so they cannot move under the load. Use a minimum of three blocks to support the keel and each side of the boat where applicable. Use a minimum total of nine jacks and/or blocks.
- Position the boat to allow for adequate draining from rain or snow.
- Cover the boat to prevent the collection of rain, snow or debris. When using a cover, allow ventilation for residual moisture and condensation to escape. Never cover or plug the boat bilge drain hole.

## STORING ON A TRAILER

- Ensure the trailer supports are adjusted to properly support the boat's hull.
- Repack the trailer wheel bearings with water-resistant wheel bearing grease.
- Park the trailer and boat in a protected area to reduce possible damage from the elements and surroundings.
- Loosen the tie-downs and winch line and ensure the boat is resting properly on hull supports.
- Lift the trailer and place blocks under the trailer frame to relieve weight on trailer tires and springs. Position the boat to allow for adequate draining from rain or snow.
- Cover the boat to prevent the collection of rain, snow or debris. When using a cover, allow ventilation for residual moisture and condensation to escape. Never cover or plug the boat bilge drain hole.

## RECOMMISSIONING AFTER STORAGE

- Remove blocks from under the trailer frame.
- Tighten tie-downs and the trailer winch line.
- Check tire pressure and lug nut tightness on the trailer.
- Inspect the hull for damage.
- Charge and install all batteries.
- Check the bilge blower vents for obstructions and blower operation.
- Check the bilge pump and float switch for proper operation.
- Inspect all battery and electrical wiring for loose connections and/or damage.
- Check the fuel system for leaks or damage.
- Check the engine and bilge for signs of nesting animals; clean as necessary.
- Check entire engine for cracks and leaks caused by freeze damage.
- Check the condition of all hoses and clamps for tightness.
- Clean the bilge area and install the boat bilge drain plug.
- Lubricate all seacocks and check for proper operation.
- Install all drain plugs in strainers and seacocks.

## Section 12

- Close all drains and valves that were opened during winterization.
- Perform any annual maintenance not performed during winterization. See the *Engine Operator's Manual* and all equipment manufacturers' information for periodic and annual maintenance procedures.
- Check the engine's cooling water intake areas and screens (if equipped) for obstructions.
- If the engine uses a self-contained cooling system and was drained for storage, fill the system with fresh coolant solution. Check the *Engine Operator's Manual* for specific procedures.
- Check all engine exhaust connections for exhaust leakage or damage.
- Check and lubricate the steering system.
- Check all navigational lights.
- Check all controls, gauges, boat systems, accessories and related equipment for proper operation.
- Check all fire extinguishers for charge level.
- Inspect all safety equipment for condition and operation as applicable.
- When possible, briefly start and run the engine(s) using proper water supply equipment to check that the engine does start and there are no major operational problems. *NOTICE: If fogging oil was used during winterization, the engine will emit excessive white smoke upon initial start-up. This condition is normal and will diminish once the fogging oil has been cleared through the engine.*
- Once the boat is in the water, start the engine.
- When the engine starts, watch gauge readings closely, checking for leaks and abnormal noises.
- Keep speeds low for the first 15 minutes until the engine has reached normal operating temperature.
- See the *Engine Operator's Manual* and all equipment manufacturers' information for additional recommendations.

## LIFTING

*NOTICE: Consult your dealer for proper lifting instructions for your boat.*

Attempt to lift or hoist boats only if you are qualified or experienced with this procedure. This procedure requires special equipment and experience. Do not attempt to lift or hoist your boat alone; damage, personal injury or death can occur. **WARNING! There are several lifting hazards to be aware of if you need to lift your boat and/or engine. See Safety Precautions in the Safety section of this manual for more details.**

If your boat is to be removed from the water without a trailer, follow these guidelines:

- Cover lifting cables with a rubber hose or other protectors to prevent damage to the finish.
- Attach guidelines to the bow and stern to control movement.
- Use spreader bars and keep lifting pressure vertical to prevent side load damage.
- Keep the bow slightly higher than the stern to prevent engine damage.

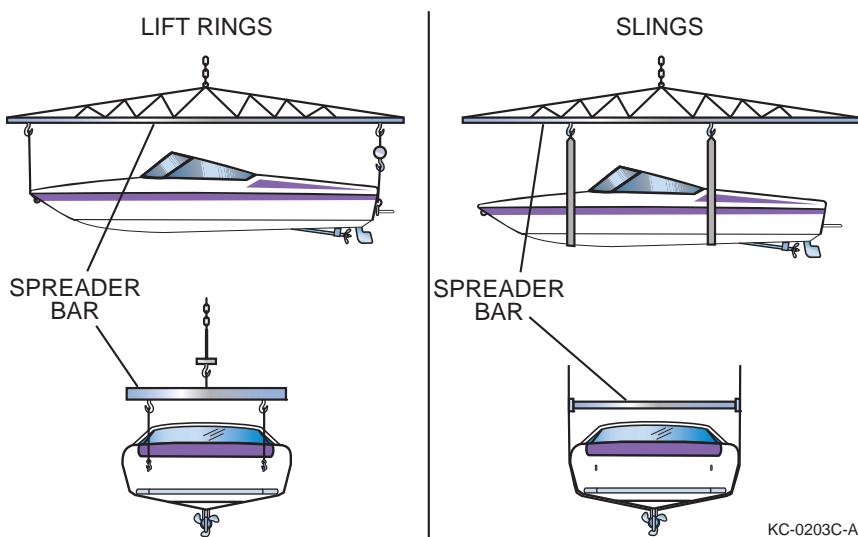

**Figure 12-1**

**This Page Intentionally Left Blank**

# CENTURION BOATS

## Section 13

# TROUBLESHOOTING

The following information will assist you in identifying basic performance, mechanical and electrical problems. This information is intended as a general troubleshooting guide and may describe items that are not applicable to your boat.

If you detect a problem with the engine, see the *Engine Operator's Manual*. If you detect an equipment or boat system problem, see the manufacturer's information for that item.

Before performing any troubleshooting procedures within this section, see *Safety on page 3-1*. **NOTICE:** *Certain problems may require specialized skills and tools. Always consult qualified personnel before making any repairs or modifications.*

Problem	Possible Causes
<b>Engine will not crank</b>	<ul style="list-style-type: none"><li>• Engine emergency stop switch lanyard not connected</li><li>• Shift/throttle control not in the NEUTRAL position</li><li>• Main circuit breaker open</li><li>• Battery switch is in the OFF position.</li><li>• Battery terminals or wiring connections corroded</li><li>• Low battery voltage</li><li>• Faulty ignition switch</li><li>• Engine problem</li></ul>
<b>Engine cranks but will not start</b>	<ul style="list-style-type: none"><li>• No fuel in tank</li><li>• Fuel tank valves closed to engine</li><li>• Fuel filter clogged</li><li>• Flame arrestor dirty, if equipped</li><li>• Contaminated fuel</li><li>• Engine problem</li></ul>

Problem	Possible Causes
<p><b>Poor boat performance</b></p>	<ul style="list-style-type: none"> <li>• Contaminated fuel</li> <li>• Uneven load distribution</li> <li>• Excessive load</li> <li>• Improper trim equipment position (if equipped)</li> <li>• Improper propeller selection</li> <li>• Excessive water in bilge</li> <li>• Damaged or obstructed propeller</li> <li>• Marine growth on hull</li> <li>• Damaged hull</li> <li>• Engine system problem</li> <li>• Plugged flame arrestor (if equipped)</li> </ul>
<p><b>Throttle/shifting control problems</b></p>	<ul style="list-style-type: none"> <li>• Corroded cable</li> <li>• Excessive bends or kinks in cable</li> <li>• Engine system problem</li> </ul>
<p><b>Excessive vibration</b></p>	<ul style="list-style-type: none"> <li>• Damaged or obstructed propeller</li> <li>• Bent propeller shaft</li> <li>• Engine system problem</li> </ul>
<p><b>Electrical problems</b></p>	<ul style="list-style-type: none"> <li>• Blown fuse/breaker or open circuit</li> <li>• Loose or corroded wiring connections</li> <li>• Defective switch or gauge</li> <li>• Weak or discharged battery</li> </ul>
<p><b>Ramfill tanks do not seem to be filling up, or they are full on the screen but you're listed to one side or another</b></p>	<ul style="list-style-type: none"> <li>• Check the "fill" valves to see if they are opening up while under way. If they are not opening up then you will not have water entering the ballast liner.</li> <li>• Check the valves in the back of the boat where the Ramfill drains are located. Are the handles all the way up? If so they are in the open position. This means when you're underway the water is rushing out of the tank (instead of staying inside the ballast liner). If this is the case push the valve back down (make sure the clip is secured in place), then "Override" the fill for Ramfill on the Touch Vision display screen until you see water coming out the vent. See Figure 13-1.</li> </ul>

Problem	Possible Causes
<b>The ramfill valves are not opening</b>	<ul style="list-style-type: none"><li>• Are you up to 10 MPH to operate Ramfill? Are you over 25 MPH?</li><li>• If all the valves are not working then the problem is most likely associated with the PDM. Check to make sure that all the electrical plug in's that go to the PDM are secure.</li><li>• Check the Pinouts on the wires that go to the PDM to see if they are dislodged. When connected, each contact of a Pinout connector must mate with the contact on the other connector that has the same function.</li><li>• If the problem continues you will need to contact your local service center to determine whether the PDM needs to be replaced.</li></ul>

## Ramfill Valve and Clip



*Figure 13-1*

**This Page Intentionally Left Blank**



# CENTURION BOATS

## Section 14

### GLOSSARY OF NAUTICAL TERMS

**ABOARD** – On or in the boat.

**ABYC** – American Boat and Yacht Council, Inc.

**AFLOAT** – On the water.

**AFT** – Toward the rear or stern of the boat.

**AGROUND** – Touching bottom.

**AMIDSHIP**– Center or middle of the boat.

**ANCHOR** – (1) An iron casting shaped to grip the lake bottom to hold the boat. (2) The act of setting the anchor.

**ASHORE** – On the shore.

**ASTERN** – Toward the stern.

**BAIL** – To remove water from the bottom of the boat with a pump, bucket, sponge, etc.

**BEAM** – The widest point on the boat.

**BEARING** – Relative position or direction of an object from the boat.

**BILGE** – The lowest interior section of the boat hull.

**BOARDING** – To enter the boat.

**BOUNDARY WATERS** – A body of water between two areas of jurisdiction; i.e., a river between two states.

**BOW** – The front of the boat.

**BULKHEAD** – Vertical partition (wall) in a boat.

**BUNKS** – Carpeted trailer hull supports.

**BURDENED BOAT** – Term for the boat that must “give-way” to boats with the right-of-way.

## Section 14

**CAPACITY PLATE** – A plate that provides maximum weight capacity and engine horsepower rating information. It is located in full view of the helm.

**CAPSIZE** – To turn over.

**CAST-OFF** – To unfasten mooring lines in preparation for departure.

**CENTER LINE** – A lengthwise imaginary line which runs fore and aft with the boat's keel.

**CHINE** – The point on a boat where the side intersects (meets) the bottom.

**CLEAT** – A deck fitting with ears to which lines are fastened.

**CONSOLE** – Also called helm. The steering wheel area of the boat.

**CRANKING BATTERY** – The main battery used for engine starting and electrical circuits.

**CURRENT** – Water moving in a horizontal direction.

**DECK** – The open surface on the boat where the passengers walk.

**DEEP-CYCLE BATTERIES** – Special long-running batteries which can be repeatedly discharged and recharged without significant loss of power.

**DOLLY WHEEL** – A rolling jack assembly at the front of the trailer used for positioning the coupler during trailer hookup.

**DRAFT** – The depth of the boat below the waterline, measured vertically to the lowest part of the hull.

**ELECTROLYSIS** – The breakup of metals due to the effects of galvanic corrosion.

**FATHOM** – Unit of depth or measure; 1 fathom equals 6 feet.

**FENDERS** – Objects placed alongside the boat for cushioning. Sometimes called bumpers.

**FORE** – Toward the front or bow of the boat. Opposite of aft.

**FREEBOARD** – The distance from the water to the gunwale.

**FUEL SENDING UNIT** – The electrical device that is mounted on the outside of a built-in fuel tank and controls the dashboard fuel gauge.

**GIVE-WAY BOAT** – (1) Term for the boat that must take whatever action necessary to keep well clear of the boat with the right-of-way in meeting or crossing situations. (2) The burdened boat.

**GUNWALE** – The rail or upper edge of a boat's side.

**HELM** – The steering wheel or command area.

**HULL** – The body of the boat.

**HYPOTHERMIA** – A physical condition where the body loses heat faster than it can produce it.

**IN-LINE FUSE** – A type of protective fuse located in the power wire of a direct current (DC) circuit usually near the battery.

**KEEL** – The lowest portion of the boat; extends fore and aft along the boat's bottom.

**LIFE JACKET**– A buoyant wearable jacket that when properly used, will support a person in the water, also see PFD.

**LIST** – Leaning or tilt of a boat toward the side.

**MAKING WAY** – Making progress through the water.

**MARINE CHART** – Seagoing maps showing depths, buoys, navigation aids, etc.

**MOORING** – An anchor, chain or similar device that holds a boat in one location.

**NAVIGATION AID** – Recognizable objects on land or sea such as buoys, towers or lights which are used to fix position to identify safe and unsafe waters.

**NMMA** – National Marine Manufacturers Association.

**NO-WAKE SPEED** – The speed at which a boat travels to produce an imperceptible wake.

**PFD** – A buoyant personal flotation device used to support a person in the water, also see Life Jacket.

**PLANING HULL** – A hull designed to lift, thereby reducing friction and increasing efficiency.

**PORPOISE** – A condition in which the bow bounces up and down.

**PORT** – (1) The left side of a boat when facing the bow. (2) A destination or harbor.

**PRIVILEGED BOAT** – Term used for the boat with the right-of-way.

**RIGHT-OF-WAY** – Term for the boat that has priority in meeting or crossing situations. The stand-on or privileged boat.

**RULES OF THE ROAD** – Regulations for preventing collisions on the water.

**SEACOCK** – A thru-hull valve or shut off on a plumbing or drain pipe between the vessel's interior and the sea.

## Section 14

**STAND ON BOAT** – Term for the boat that must maintain course and speed in meeting or crossing situations. The privileged boat.

**STARBOARD** – The right side of the boat when looking toward the bow.

**STERN** – The back of the boat.

**STOW** – To pack the cargo.

**SURGE BRAKES** – A type of trailer braking system designed to automatically actuate when the tow vehicle's brakes are applied.

**TRANSDUCER** – The unit that sends/receives signals for the depth sounder.

**TRANSOM** – The transverse beam across the stern.

**TRIM** – Fore-to-aft and side-to-side balance of the boat when loaded.

**UNDER WAY** – Boat in motion; i.e., not moored or anchored.

**USCG** – United States Coast Guard.

**WAKE** – The waves that a boat leaves behind when moving through the water.

**WATERWAY** – A navigable body of water.

**V-PAD** – A modified vee-hull design with a small, flat area in the keel aft.

**VISUAL DISTRESS SIGNAL** – A device used to signal the need for assistance such as flags, lights and flares.

## Notes

## Notes